

Neural Networks

1. Introduction

Spring 2025

Logistics: By now you must have...

- Already seen the logistics post on piazza
 - And possibly watched lecture 0 (logistics)
 - If not do so at once
- Been to the course website
 - <http://deeplearning.cs.cmu.edu>
 - If you have not done so, please visit it at once
- Course objectives, logistics, quiz and homework policies, and grading policies, all have been explained in both, the logistics lecture and on the course page
- Please familiarize yourself with this information at once

Logistics: Part 2

- You should already have
 - Signed on to piazza
 - Verified you have access to canvas and autolab
- You will get a note on forming study groups
 - We recommend this; you learn better in teams than you do by yourself

**– Please sign up for the study groups
*immediately!!!!!!!!!!!!***

Course philosophy and resources

- No student left behind : In our ideal world everyone of you would **earn** an A
- Please use the available resources
 - TAs
 - Study groups and TA mentors
 - Collaboration is encouraged
 - Dozens of office hours weekly
 - Me (email me, or just walk into my office if I'm free)
 - Your classmates and friends
- If under stress/unable to perform, please reach out
 - To your TA mentor
 - To me
 - We will do our best to help you

This Saturday

- On Saturday 18st, we will have a meet-and-greet + lab + hackathon
 - Meet your colleagues, make some friends/collaborators, form study groups
 - If you already have a study group, come as a group
 - Learn how to get started with DL code
 - Pizza, not piazza!!!

Course Objectives: By the end of the course you will be able to...

1. Understand some of the theory behind neural networks
2. Build your own neural net components and tools
3. Work on large-scale problems

Course Objectives: By the end of the course you will be able to...

1. Understanding some of the theory behind neural networks
 - The what, the why and the how
 - The math
 - And the occasional history
 - Will help you contextualize 2 and 3 below
 - Will help you develop and extend your ideas in the topic
 - Research / Grad school
 - And job interviews!
2. Build your own neural net components and tools
3. Work on large-scale problems

Course Objectives: By the end of the course you will be able to...

1. Understanding some of the theory behind neural networks

2. Build your own neural net components and tools

- Part 1s of your homeworks
- Bonus problems

3. Work on large-scale problems

Course Objectives: By the end of the course you will be able to...

1. Understanding some of the theory behind neural networks
2. Build your own neural net components and tools
3. Work on large-scale problems
 - Part 2s of your homeworks

Course Objectives: By the end of the course you will be able to...

1. Understanding some of the theory behind neural networks
 2. Build your own neural net components and tools
 3. Work on large-scale problems
- Course projects may relate to 1, 2 or 3

Lecture Style

- My lecture style is verbose, with lots of visualization
- Many many slides
 - With a lot of animation
- Given a choice between deriving an equation symbolically, and explaining it with 30 slides of pictures and animation, I usually choose the latter
- If this is not your cup of tea, this is not the class for you

Attendance

- We will use in-class polls for class participation
 - Multiple polls posted at random times through the class
 - Polls will be posted on piazza
 - Please keep your piazza (and *only* your piazza) open
 - You must respond to all polls
 - We don't score you on correctness, only on whether you responded
- Students who have permission to view videos instead:
please watch mediatech videos
 - We will gather your attendance from there

Classroom Engagement



- This is an interactive class
- We like questions
 - No question is silly/wrong/embarrassing
 - If you have a question, odds are that others have it too
- We will try different tactics to encourage interaction
 - E.g. calling out to students
- Please participate

For your entertainment

- "Professor Ramakrishnan is one of the rudest professors I have had during my university studies, and he makes some rather bizarre decisions about how he teaches his class. The university has required lectures to be recorded in case students can't attend during regular class times, but Dr. Ramakrishnan continues to require attendance despite also checking student understanding with weekend quizzes. He treats graduate students like high school students by checking that we are paying attention using additional pop quizzes. I considered starting to ask for permission to go to the restroom (to not miss any pop quizzes), but I figured that it is a bad idea to criticize the person with power over my grade."
- From one of my FCEs 🙄

Classroom Engagement: 2

- This is a “dumb” classroom
 - Keep your smart devices shut
 - No phones or laptops open except for the following:
- Exceptions:
 - To answer polls
 - To view lecture slides
 - To take notes
 - If we find you using your devices for any other purpose, we may ask you to leave the room

I'm handicapped

- I'm physically handicapped
- My back and neck are bent. I cannot raise my arms. On some days I cannot walk. My breath runs out midway through the lecture
- Please do not mind my mannerisms
 - During classroom lectures I may ask my TAs to clip on my mic
 - I cannot do so myself
 - I use strange devices to point, because they are light
 - I cannot raise my arm enough to point

A minute for questions...



Caveat: Slide deck often have many "hidden" slides that will not be shown during the lecture, but will feature in your weekly quizzes

Today's lessons

- A brief history of neural networks
 - Connectionism
 - Its relation to cognition and the brain
 - Its contrast to conventional computer architecture
 - Early models, and their limitations
- Introducing modern neural networks
- And what they can compute

Neural Networks are taking over!

- Neural networks have become one of *the* main approaches to AI
- They have been successfully applied to various pattern recognition, prediction, and analysis problems
- In many problems they have established the state of the art
 - Often exceeding previous benchmarks by large margins
 - Sometimes solving problems you couldn't solve using earlier ML methods

Breakthroughs with neural networks (2016)

TECHNEWSWORLD EMERGING TECH

Computing Internet IT Mobile Tech Reviews Security Technology Tech Blog Reader Services

Microsoft AI Beats Humans at Speech Recognition

By Richard Adhikari
Oct 20, 2016 11:40 AM PT

Print Email

Reasoning Artificial Intelligence Computer Knowledge Technology Learning

Science System

AI

Image: Adobe Stock

Microsoft's Artificial Intelligence and Research Unit earlier this week reported that its speech recognition technology had surpassed the performance of human transcriptionists.

How do you feel about Black Friday and Cyber Monday?

- They're great -- I get a lot of bargains!
- The deals are too spread out -- I'd prefer just one day.
- They're a fun way to kick off the holiday season.
- I don't like the commercialization of Thanksgiving Day.
- They're crucial for the retail industry and the economy.
- The deals typically aren't that good.

Vote to See Results

E-Commerce Times

Black Friday Shoppers Hungry for New Experiences, New Tech

Pay TV's Newest Innovation: Giving Users Control

Apple Celebrates Itself in \$300 Coffee Table Tome

AWS Enjoys Top Perch in IaaS, PaaS Markets

US Comptroller Gears Up for Blockchain and

Breakthrough with neural networks (2016)

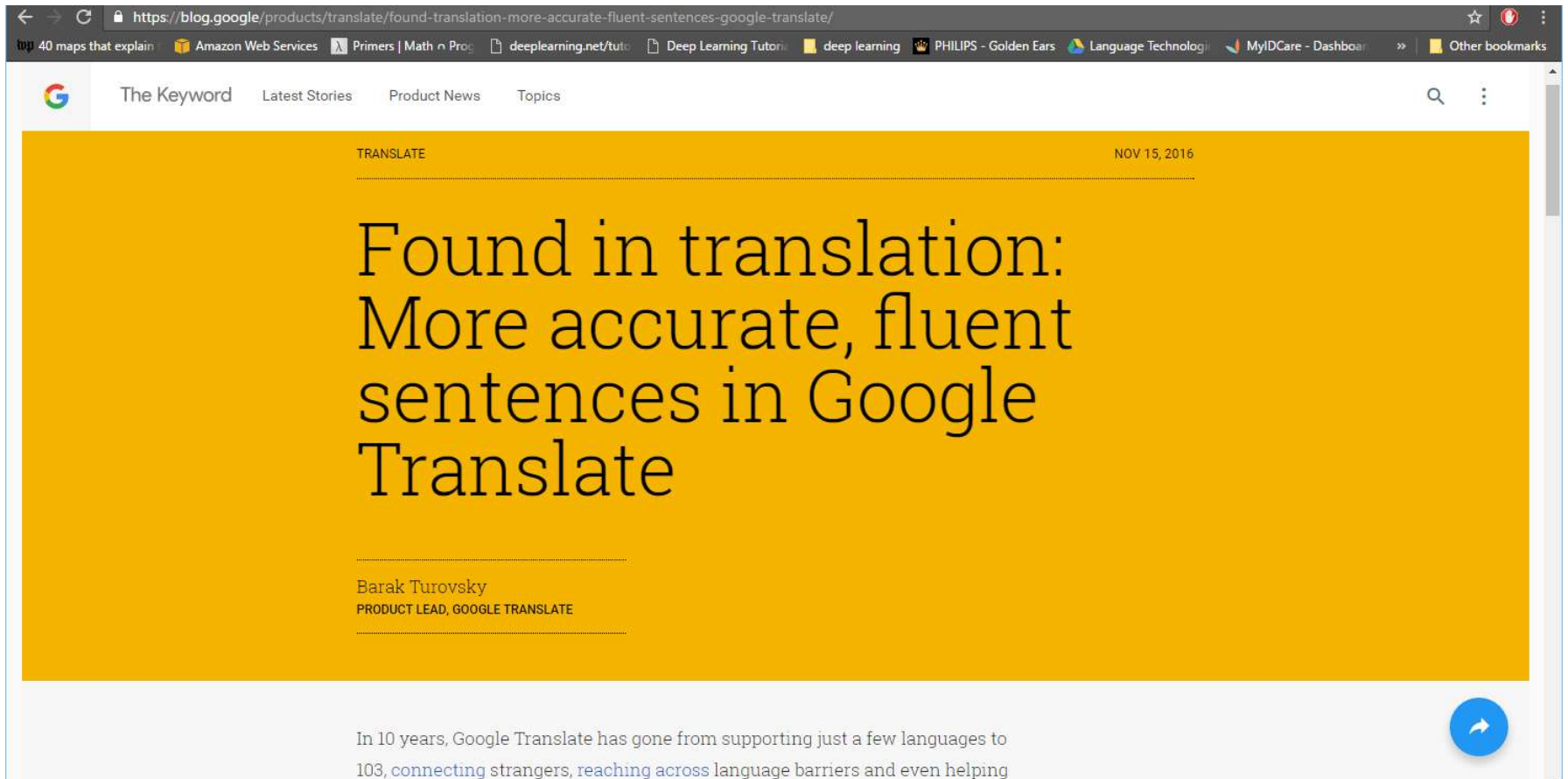

The image shows a screenshot of a web browser displaying a Google blog post. The browser's address bar shows the URL: <https://blog.google/products/translate/round-translation-more-accurate-fluent-sentences-google-translate/>. The browser's bookmark bar contains several items, including "40 maps that explain", "Amazon Web Services", "Primers | Math n Proc", "deeplearning.net/tuto", "Deep Learning Tutori", "deep learning", "PHILIPS - Golden Ears", "Language Technologi", "MyIDCare - Dashboar", and "Other bookmarks". The blog post header includes the Google logo, "The Keyword", "Latest Stories", "Product News", and "Topics". The main content area has a yellow background and features the word "TRANSLATE" in the top left and "NOV 15, 2016" in the top right. The title of the post is "Found in translation: More accurate, fluent sentences in Google Translate". Below the title, the author's name "Barak Turovsky" and his title "PRODUCT LEAD, GOOGLE TRANSLATE" are listed. At the bottom of the page, a snippet of text reads: "In 10 years, Google Translate has gone from supporting just a few languages to 103, connecting strangers, reaching across language barriers and even helping". A blue circular share button is visible in the bottom right corner.

TRANSLATE NOV 15, 2016

Found in translation: More accurate, fluent sentences in Google Translate

Barak Turovsky
PRODUCT LEAD, GOOGLE TRANSLATE

In 10 years, Google Translate has gone from supporting just a few languages to 103, connecting strangers, reaching across language barriers and even helping

Breakthroughs with neural networks (2016)

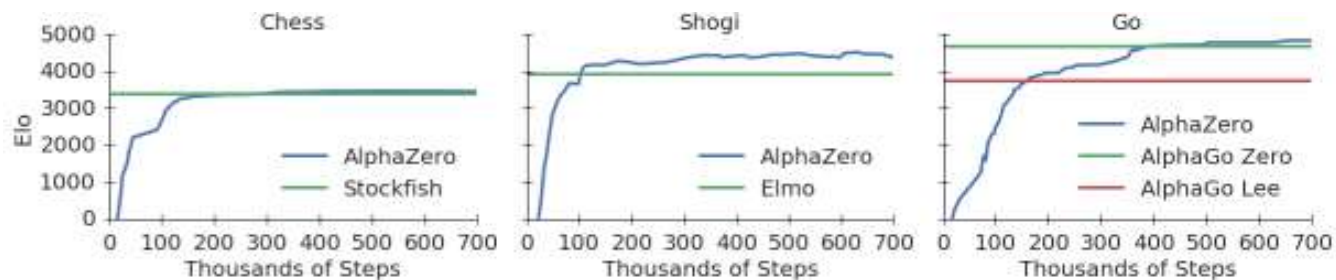
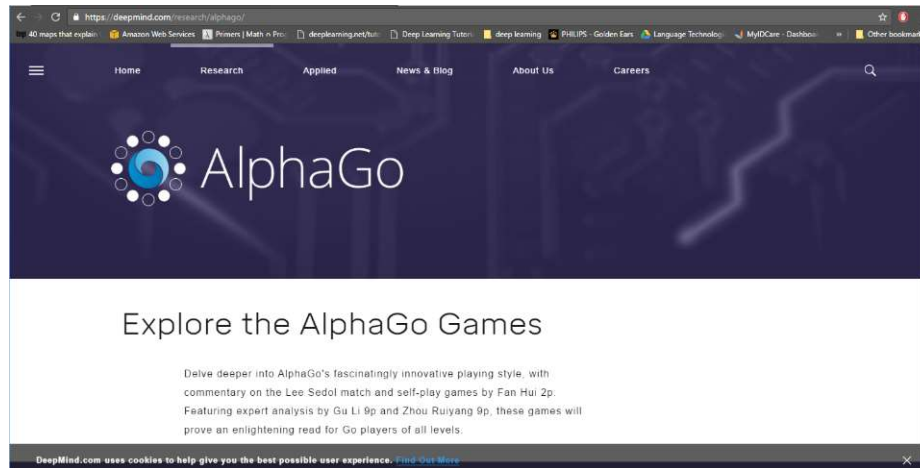
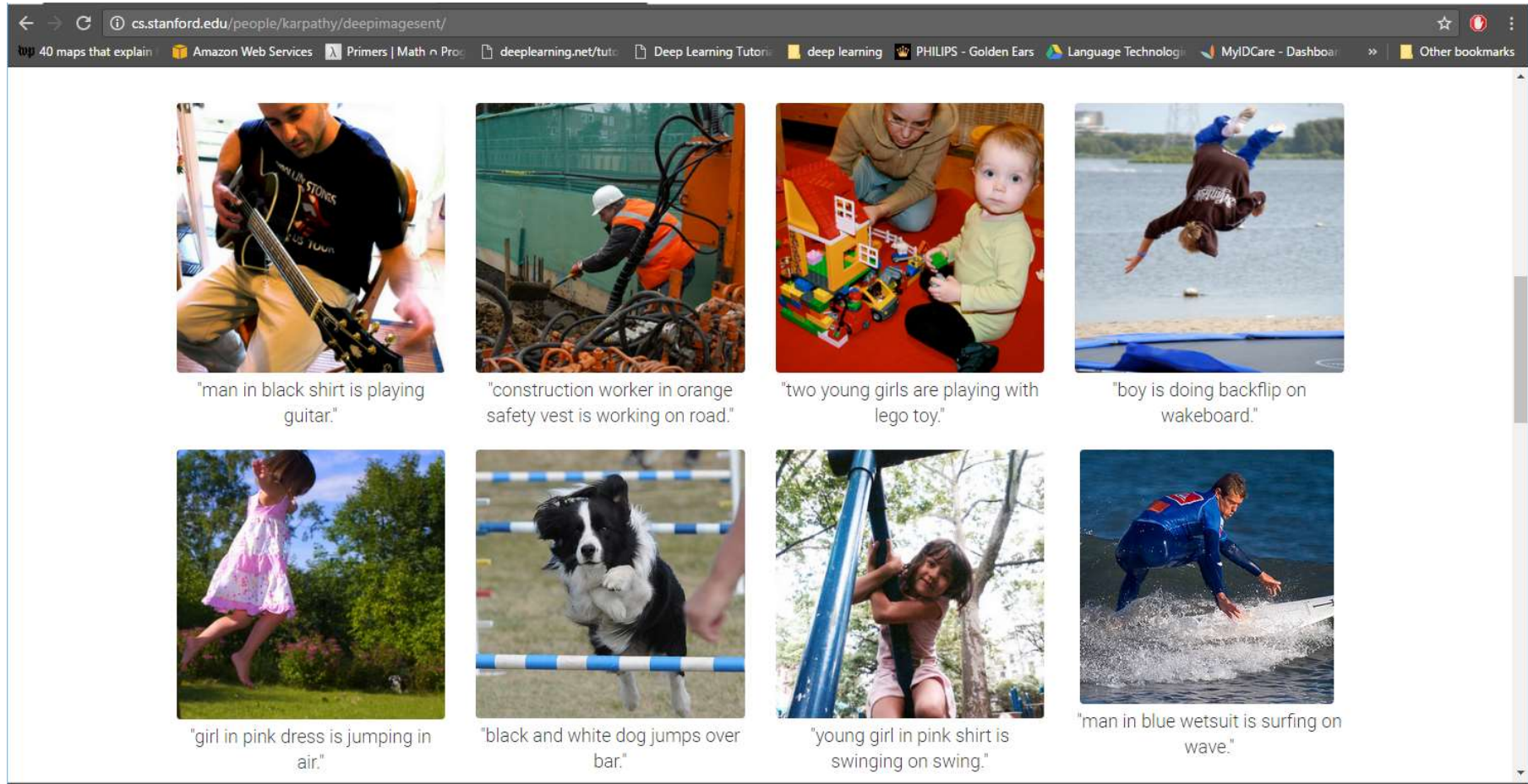









Figure 1: Training *AlphaZero* for 700,000 steps. Elo ratings were computed from evaluation games between different players when given one second per move. **a** Performance of *AlphaZero* in chess, compared to 2016 TCEC world-champion program *Stockfish*. **b** Performance of *AlphaZero* in shogi, compared to 2017 CSA world-champion program *Elmo*. **c** Performance of *AlphaZero* in Go, compared to *AlphaGo Lee* and *AlphaGo Zero* (20 block / 3 day) (29).

Success with neural networks (2016)



The screenshot shows a web browser window with the address bar displaying `cs.stanford.edu/people/karpathy/deepimagesent/`. The browser's bookmark bar contains several entries, including "40 maps that explain", "Amazon Web Services", "Primers | Math n Proc", "deeplearning.net/tut...", "Deep Learning Tutori...", "deep learning", "PHILIPS - Golden Ears", "Language Technologi...", "MyIDCare - Dashboar...", and "Other bookmarks". The main content area displays a 2x4 grid of images, each with a caption generated by a neural network.

			
<p>"man in black shirt is playing guitar."</p>	<p>"construction worker in orange safety vest is working on road."</p>	<p>"two young girls are playing with lego toy."</p>	<p>"boy is doing backflip on wakeboard."</p>
			
<p>"girl in pink dress is jumping in air."</p>	<p>"black and white dog jumps over bar."</p>	<p>"young girl in pink shirt is swinging on swing."</p>	<p>"man in blue wetsuit is surfing on wave."</p>

- Captions generated entirely by a neural network

And now...

ChatGPT, tell me about this picture

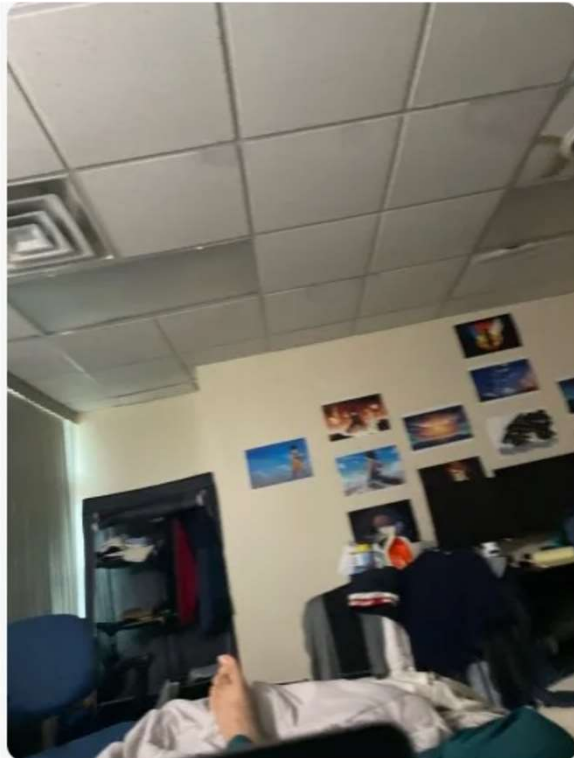

7:12 PM The ceiling in the photo appears to have several noticeable water stains, which could indicate potential water damage. The stains seem to be spread across multiple tiles, suggesting there might be a leak from the roof or pipes above. It would be advisable to address this issue promptly to prevent any further damage or potential mold growth. Notifying building maintenance or the landlord to investigate and fix the source of the leak would be the best course of action.

Besides the water stains on the ceiling, the photo shows a few other details:

1. **Posters on the Wall:** There are several posters or prints on the wall featuring various images, likely of scenes from movies, video games, or other forms of media.
2. **Furniture and Clutter:** The room contains a few pieces of furniture, including a blue chair, a black wardrobe or storage unit, and a desk with two monitors. There are clothes and other items visible on the wardrobe and desk, indicating a typical lived-in space.
3. **Lighting and Ventilation:** The ceiling has a light fixture and an air vent, suggesting this is a standard room with typical building amenities.
4. **Bed and Bedding:** The lower part of the photo shows a bed with a person lying on it, with their foot visible in the foreground. The bed has a comforter and some clothing or linens on it.
5. **Overall Condition:** The room appears somewhat cluttered, with personal belongings spread out. The presence of water stains on the ceiling is the most concerning issue visible.

Successes with neural networks

- And a variety of other problems:
 - From art to astronomy to healthcare..
 - and even predicting stock markets!

So, what are neural networks??

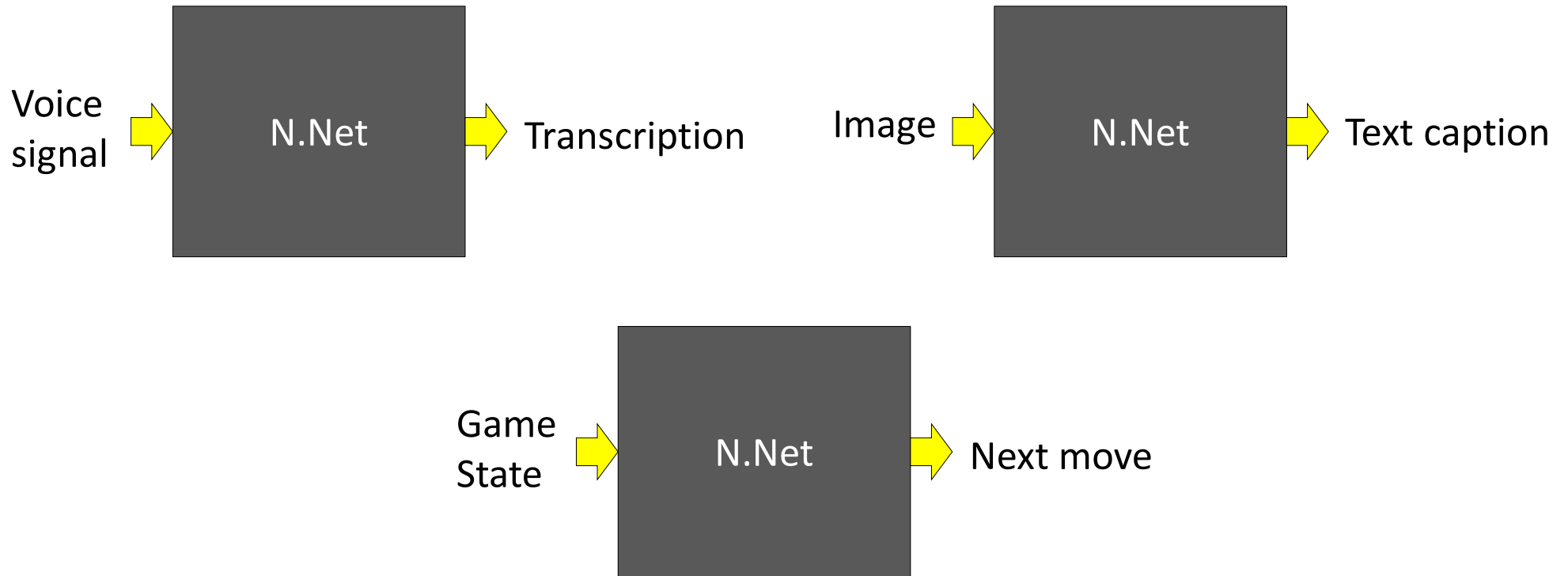

- What's in these boxes?

So, what are neural networks??



- It begins with this..

So, what are neural networks??

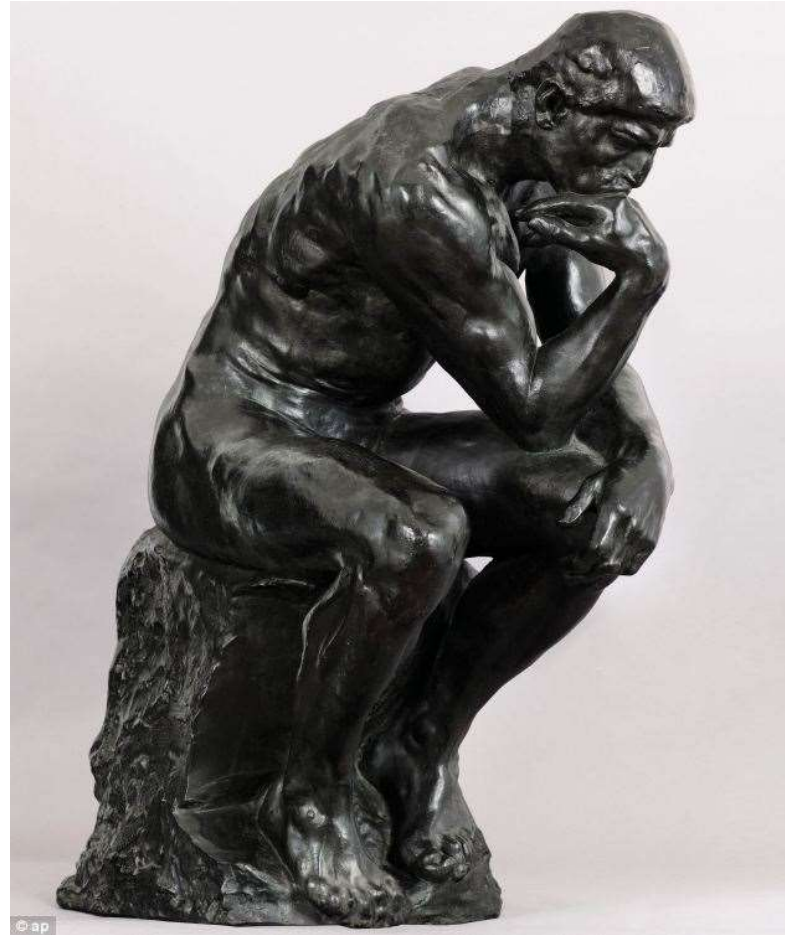

"The Thinker!"
by Augustin Rodin

- Or even earlier.. with this..

The magical capacity of humans

- Humans can
 - Learn
 - Solve problems
 - Recognize patterns
 - Create
 - Cogitate
 - ...
- Worthy of emulation
- But how do humans “work“?



Dante!

Cognition and the brain..

- “If the brain was simple enough to be understood - we would be too simple to understand it!”
 - Marvin Minsky

Early Models of Human Cognition



- **Associationism**
 - Humans learn through association
- **400BC-1900AD:** Plato, David Hume, Ivan Pavlov..

What are “Associations”

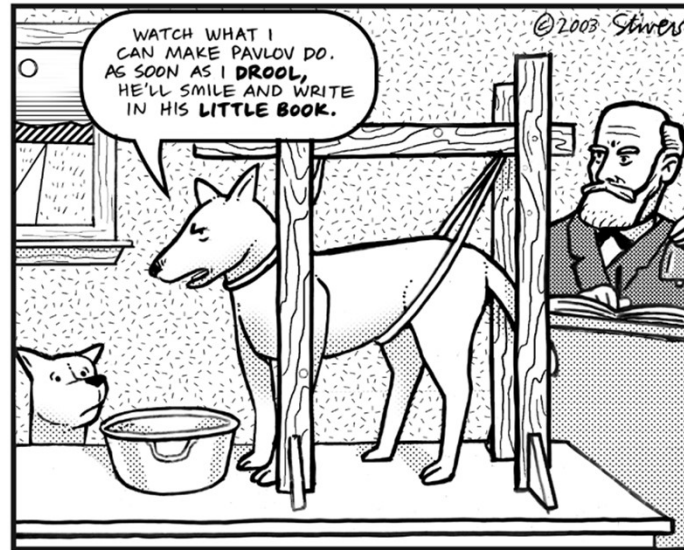

- Lightning is generally followed by thunder
 - Ergo – “hey here’s a bolt of lightning, we’re going to hear thunder”
 - Ergo – “We just heard thunder; did someone get hit by lightning”?
- Association!

A little history : Associationism

- Collection of ideas stating a basic philosophy:
 - “Pairs of thoughts become associated based on the organism’s past experience”
 - **Learning** is a mental process that forms associations between temporally related phenomena
- 360 BC: Aristotle
 - "Hence, too, it is that we hunt through the mental train, excogitating from the present or some other, and from similar or contrary or coadjacent. Through this process reminiscence takes place. For the movements are, in these cases, sometimes at the same time, sometimes parts of the same whole, so that the subsequent movement is already more than half accomplished."
 - In English: *we memorize and rationalize through association*



Aristotle and Associationism



- Aristotle's four laws of association:
 - *The law of contiguity.* Things or events that occur close together in space or time get linked together
 - *The law of frequency.* The more often two things or events are linked, the more powerful that association.
 - *The law of similarity.* If two things are similar, the thought of one will trigger the thought of the other
 - *The law of contrast.* Seeing or recalling something may trigger the recollection of something opposite.

A little history : **Associationism**

- More recent associationists (upto 1800s): John Locke, David Hume, David Hartley, James Mill, John Stuart Mill, **Alexander Bain**, Ivan Pavlov
 - Associationist theory of mental processes: *there is only one mental process: the ability to associate ideas*
 - Associationist theory of learning: *cause and effect, contiguity, resemblance*
 - Behaviorism (early 20th century) : *Behavior is learned from repeated associations of actions with feedback*
 - Etc.

- **But where are the associations stored??**
- **And how?**

But how do we *store* them?

Dawn of Connectionism

David Hartley's *Observations on man* (1749)

- We receive input through vibrations and those are transferred to the brain
- Memories could also be small vibrations (called vibratiuncles) in the same regions
- Our brain represents compound or connected ideas by connecting our memories with our current senses
- Current science did not know about neurons

Observation: *The Brain*



- Mid 1800s: The brain is a mass of interconnected neurons

Brain: Interconnected Neurons



- Many neurons connect *in* to each neuron
- Each neuron connects *out* to many neurons
- The brain is a *network* of neurons

Enter *Connectionism*



- Alexander Bain, philosopher, psychologist, mathematician, logician, linguist, professor
- **1873: The information is in the *connections***
 - *Mind and body* (1873)

Bain's Idea 1: Neural Groupings

- Neurons excite and stimulate each other
- Different combinations of inputs can result in different outputs

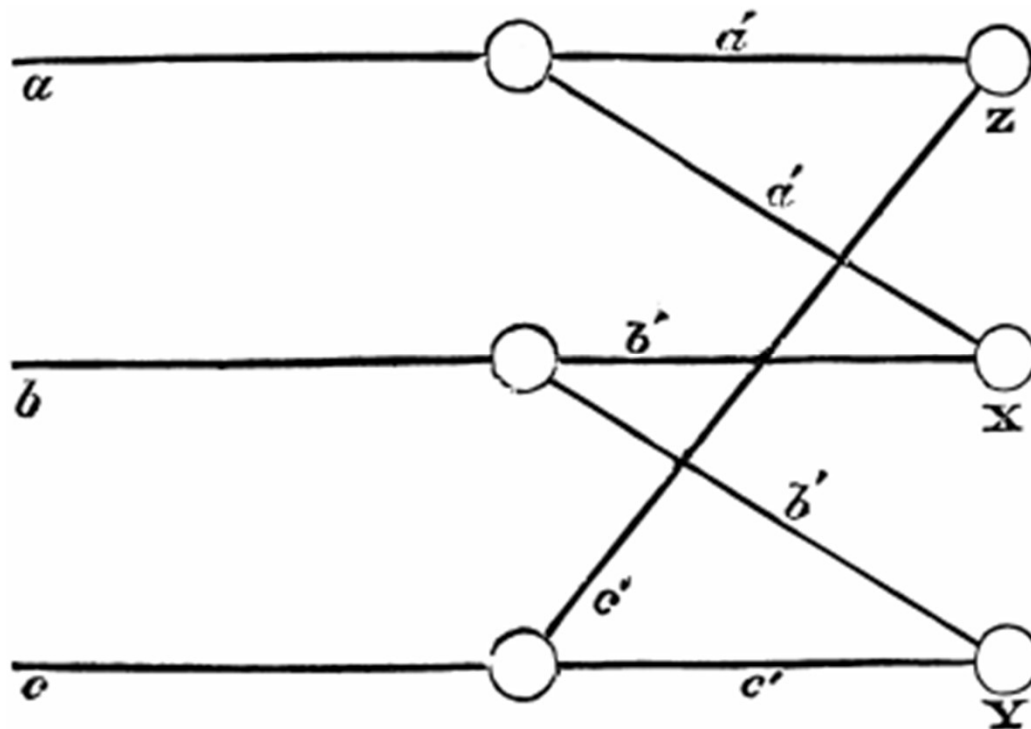

Bain's Idea 1: Neural Groupings

- Different intensities of activation of A lead to the differences in when X and Y are activated
- Even proposed a learning mechanism..

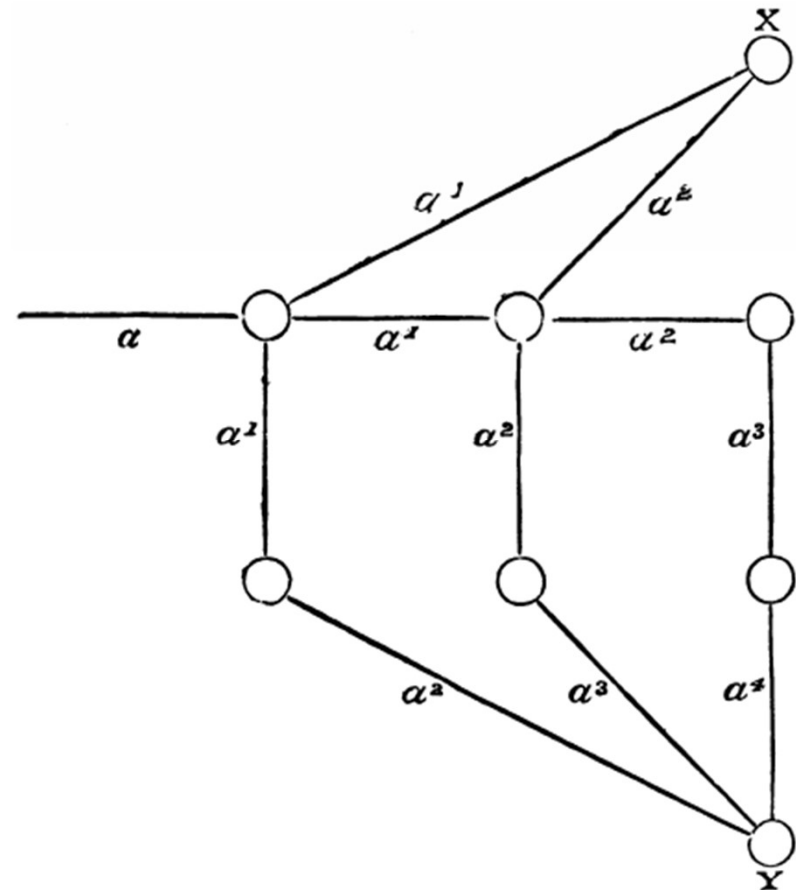

Bain's Idea 2: Making Memories

- “when two impressions concur, or closely succeed one another, the nerve-currents find some bridge or place of continuity, better or worse, according to the abundance of nerve-matter available for the transition.”
- Predicts “Hebbian” learning (three quarters of a century before Hebb!)

Bain's Doubts

- *“The fundamental cause of the trouble is that in the modern world the stupid are cocksure while the intelligent are full of doubt.”*
 - Bertrand Russell
- In 1873, Bain postulated that there must be one million neurons and 5 billion connections relating to 200,000 “acquisitions”
- In 1883, Bain was concerned that he hadn't taken into account the number of “partially formed associations” and the number of neurons responsible for recall/learning
- By the end of his life (1903), recanted all his ideas!
 - Too complex; the brain would need too many neurons and connections

Connectionism lives on..

- The human brain is a connectionist machine
 - Bain, A. (1873). *Mind and body. The theories of their relation*. London: Henry King.
 - Ferrier, D. (1876). *The Functions of the Brain*. London: Smith, Elder and Co
- Neurons connect to other neurons. The processing/capacity of the brain is a function of these connections
- Connectionist machines emulate this structure

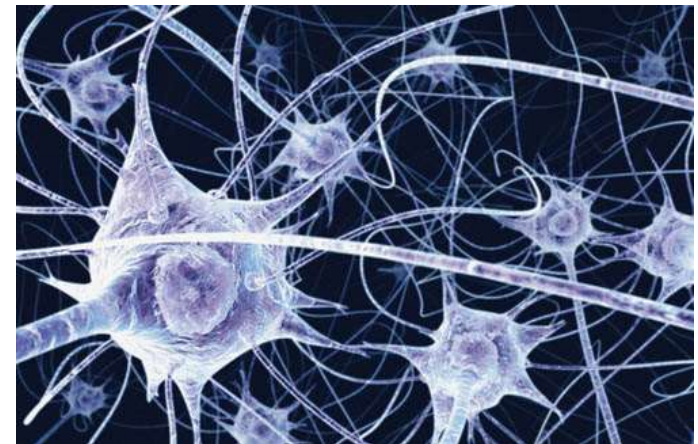

Connectionist Machines

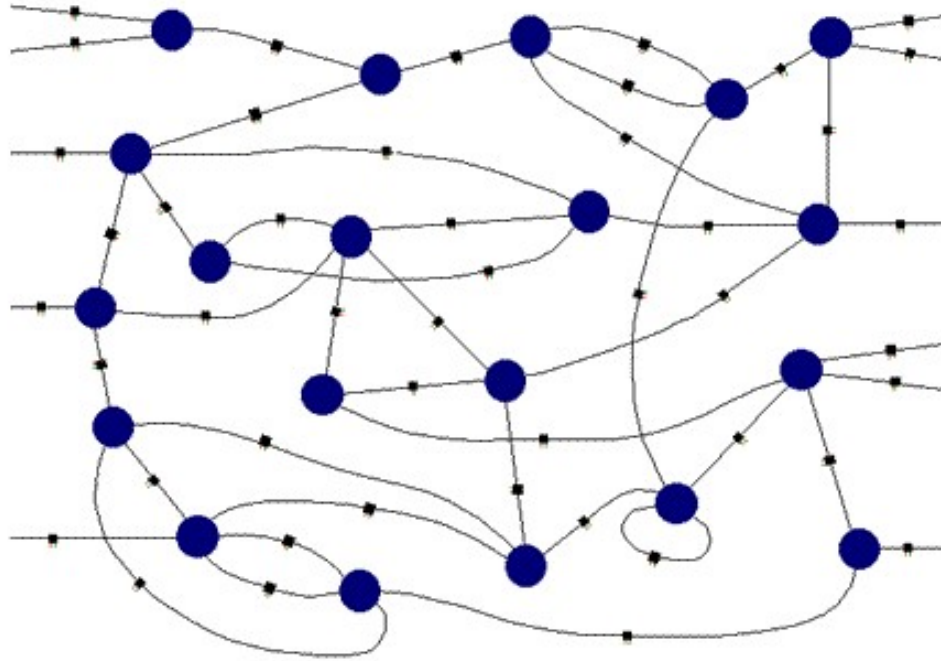

- Network of processing elements
- **All world knowledge is stored in the *connections* between the elements**

Connectionist Machines

- Neural networks are *connectionist* machines
 - As opposed to Von Neumann Machines

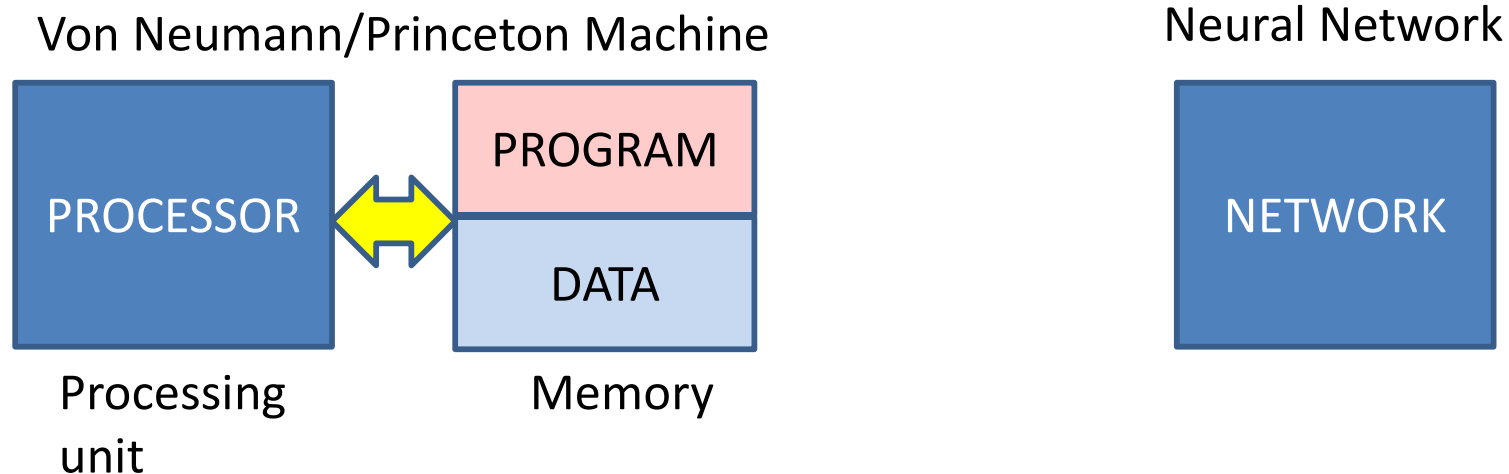

- The machine has many non-linear processing units
 - The program is the connections between these units
 - Connections may also define memory

Recap

- Neural network based AI has taken over most AI tasks
- Neural networks originally began as computational models of the brain
 - Or more generally, models of cognition
- The earliest model of cognition was *associationism*
- The more recent model of the brain is *connectionist*
 - Neurons connect to neurons
 - The workings of the brain are encoded in these connections
- Current neural network models are *connectionist machines*

Poll 1

1. Who is the first person that proposed connectionism? (Single Choice):

- Aristotle
- Alexander Bain
- David Hartley
- Alan Turing

2. Roughly how many connections exist between neurons in the brain? (Single Choice):

- 1 million
- 5 billion
- 80 billion
- 100 trillion

Poll 1

1. Who is the first person that proposed connectionism? (Single Choice):

- Aristotle
- **Alexander Bain**
- David Hartley
- Alan Turing

2. Roughly how many connections exist between neurons in the brain? (Single Choice):

- 1 million
- 5 billion
- 80 billion
- **100 trillion**

Connectionist Machines

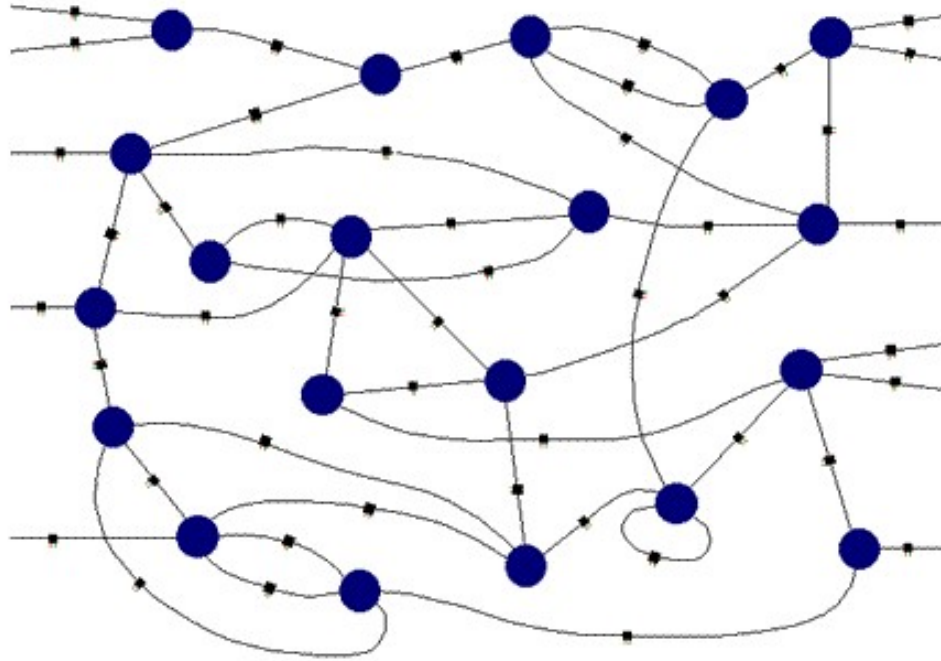

- Network of processing elements
- All world knowledge is stored in the *connections* between the elements
- *Multiple* connectionist paradigms proposed..

Turing's Connectionist Machines

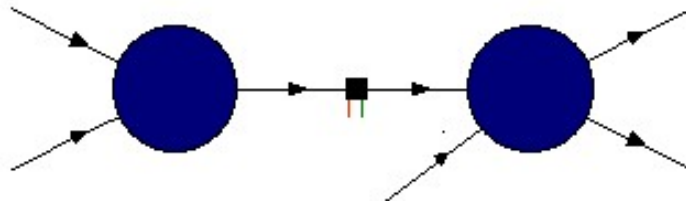
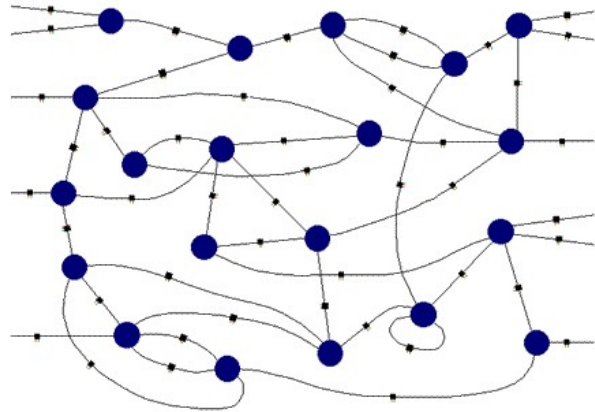

- **Alan Turing's** Connectionist model (1948): Learnable networks that could potentially be trained to model any Boolean function!
- Basic model: A-type machines
 - Random networks of NAND gates, with no learning mechanism
 - “Unorganized machines”
- Connectionist model: B-type machines (1948)
 - Connection between two units has a “modifier”
 - Whose behaviour can be learned
 - If the green line is on, the signal sails through
 - If the red is on, the output is fixed to 1
 - “Learning” – figuring out how to manipulate the coloured wires
 - Done by an A-type machine

Connectionist paradigms: PDP

Parallel Distributed Processing

- Requirements for a PDP system
(Rumelhart, Hinton, McClelland, '86; quoted from Medler, '98)
 - A set of processing units
 - A state of activation
 - An output function for each unit
 - A pattern of connectivity among units
 - A propagation rule for propagating patterns of activities through the network of connectivities
 - An activation rule for combining the inputs impinging on a unit with the current state of that unit to produce a new level of activation for the unit
 - A learning rule whereby patterns of connectivity are modified by experience
 - An environment within which the system must operate

Connectionist Systems

- Requirements for a connectionist system (Bechtel and Abrahamson, 91)
 - The connectivity of units
 - The activation function of units
 - The nature of the learning procedure that modifies the connections between units, and
 - How the network is interpreted semantically

Connectionist Machines

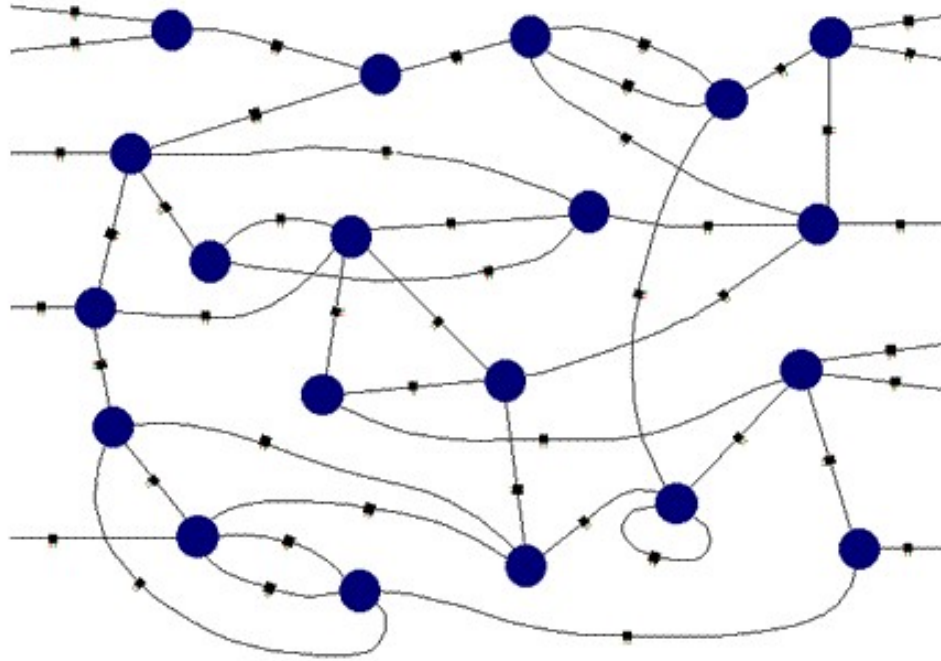

- Network of processing elements
 - All world knowledge is stored in the *connections* between the elements
- *But what are the individual elements?*

Modelling the brain

- What are the units?
- A neuron:

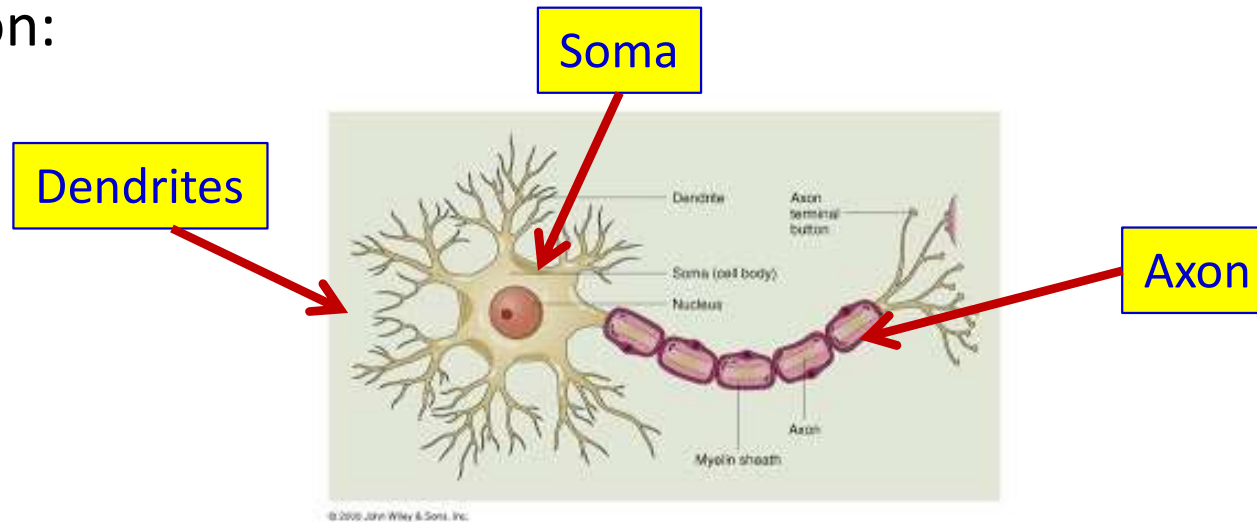

- Signals come in through the dendrites into the Soma
- A signal goes out via the axon to other neurons
 - Only one axon per neuron
- Factoid that may only interest me: Neurons do not undergo cell division
 - Neurogenesis occurs from neuronal stem cells, and is minimal after birth

McCulloch and Pitts

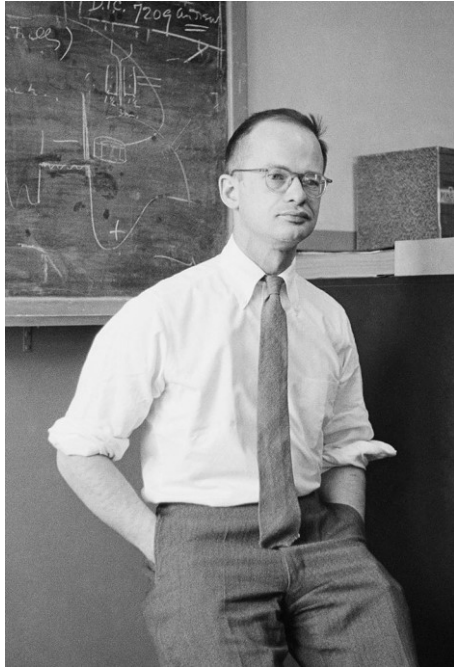

- The Doctor and the Hobo..
 - Warren McCulloch: Neurophysiologist
 - Walter Pitts: Homeless wannabe logician who arrived at his door

The McCulloch and Pitts model

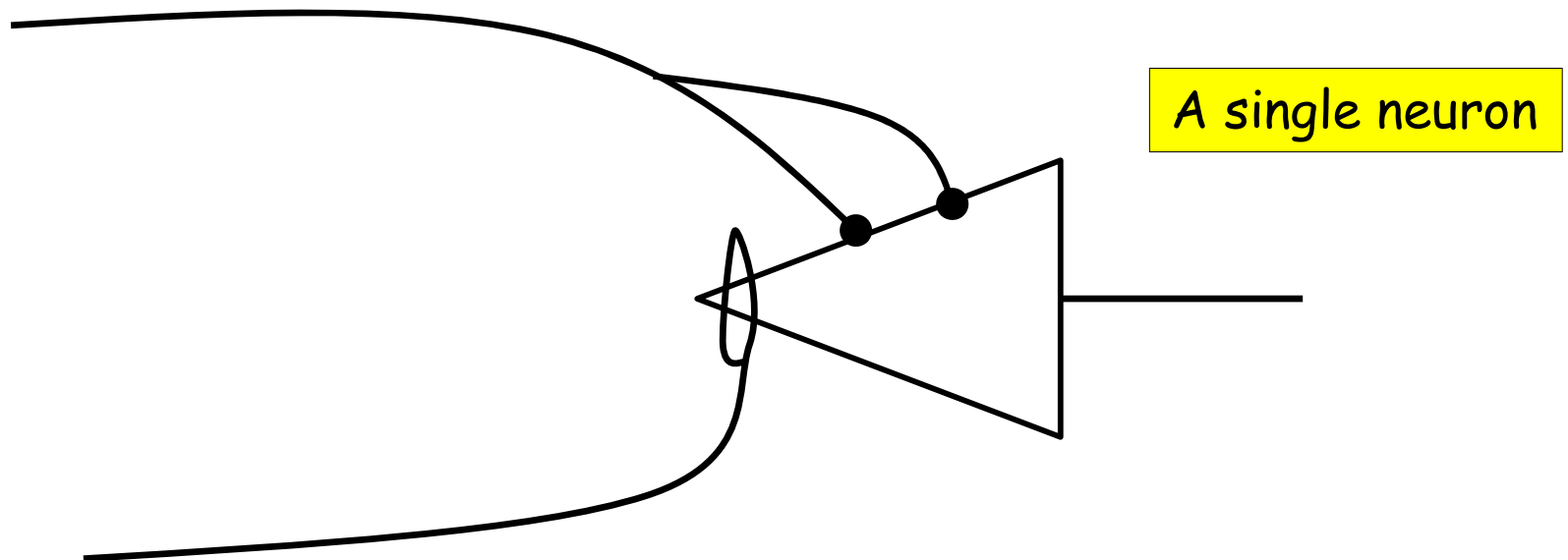

- A mathematical model of a neuron
 - McCulloch, W.S. & Pitts, W.H. (1943). A Logical Calculus of the Ideas Immanent in Nervous Activity, Bulletin of Mathematical Biophysics, 5:115-137, 1943
 - Pitts was only 20 years old at this time
- Modeled the neurons of the brain (and the brain itself) as performing propositional logic, where each neuron evaluates the truth value of its input (propositions)
 - Effectively Boolean logic

Synaptic Model

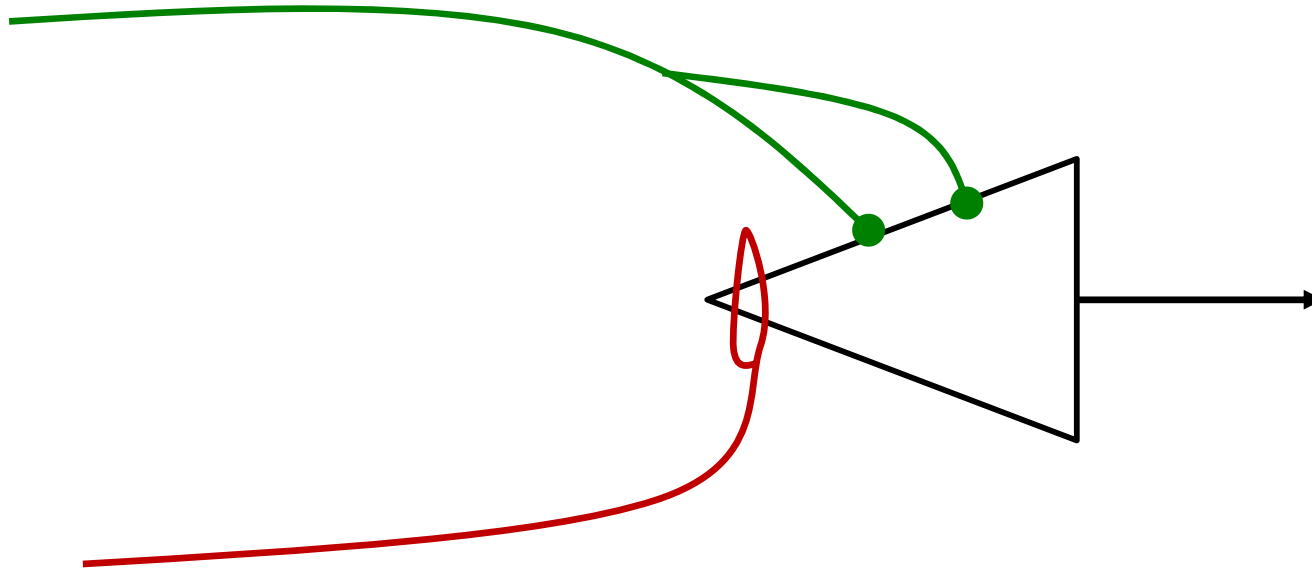

- **Excitatory synapse:** Transmits weighted input to the neuron
- **Inhibitory synapse:** Any signal from an inhibitory synapse prevents neuron from firing
 - The activity of any inhibitory synapse absolutely prevents excitation of the neuron at that time.
 - Regardless of other inputs

Simple "networks" of neurons can perform Boolean operations

Boolean Gates

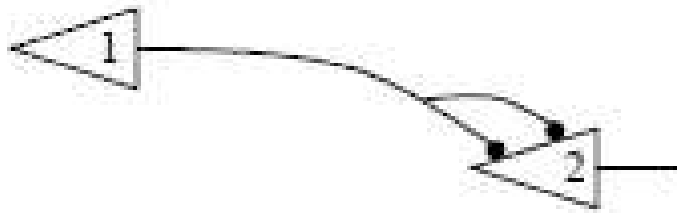

$N_2(t) \leftrightarrow N_1(t-1)$
net for temporal predecessor

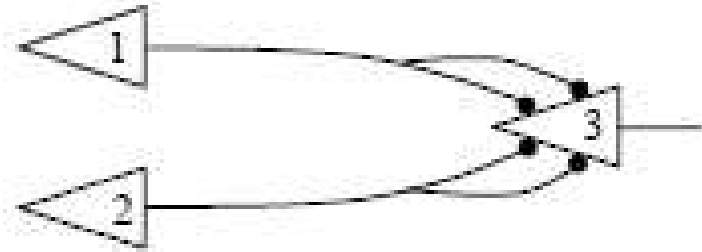

$N_3(t) \leftrightarrow N_1(t-1) \vee N_2(t-1)$
net for disjunction

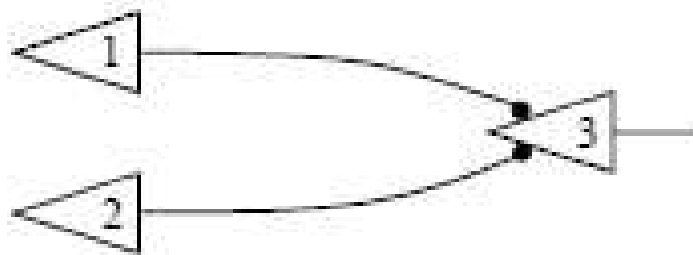

$N_3(t) \leftrightarrow N_1(t-1) \& N_2(t-1)$
net for conjunction

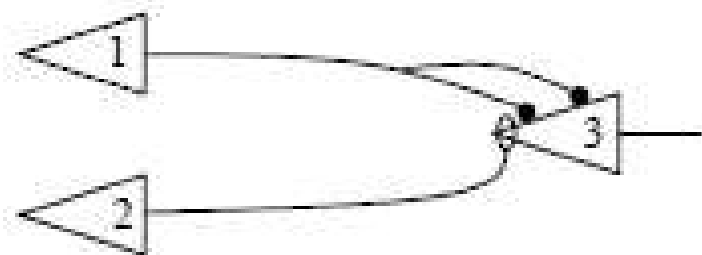

$N_3(t) \leftrightarrow N_1(t-1) \& \sim N_2(t-1)$
net for conjunction and negation

Figure 1. Diagrams of McCulloch and Pitts nets. In order to send an output pulse, each neuron must receive two excitory inputs and no inhibitory inputs. Lines ending in a dot represent excitatory connections; lines ending in a hoop represent inhibitory connections.

Complex Percepts & Inhibition in action

They can even create illusions of "perception"

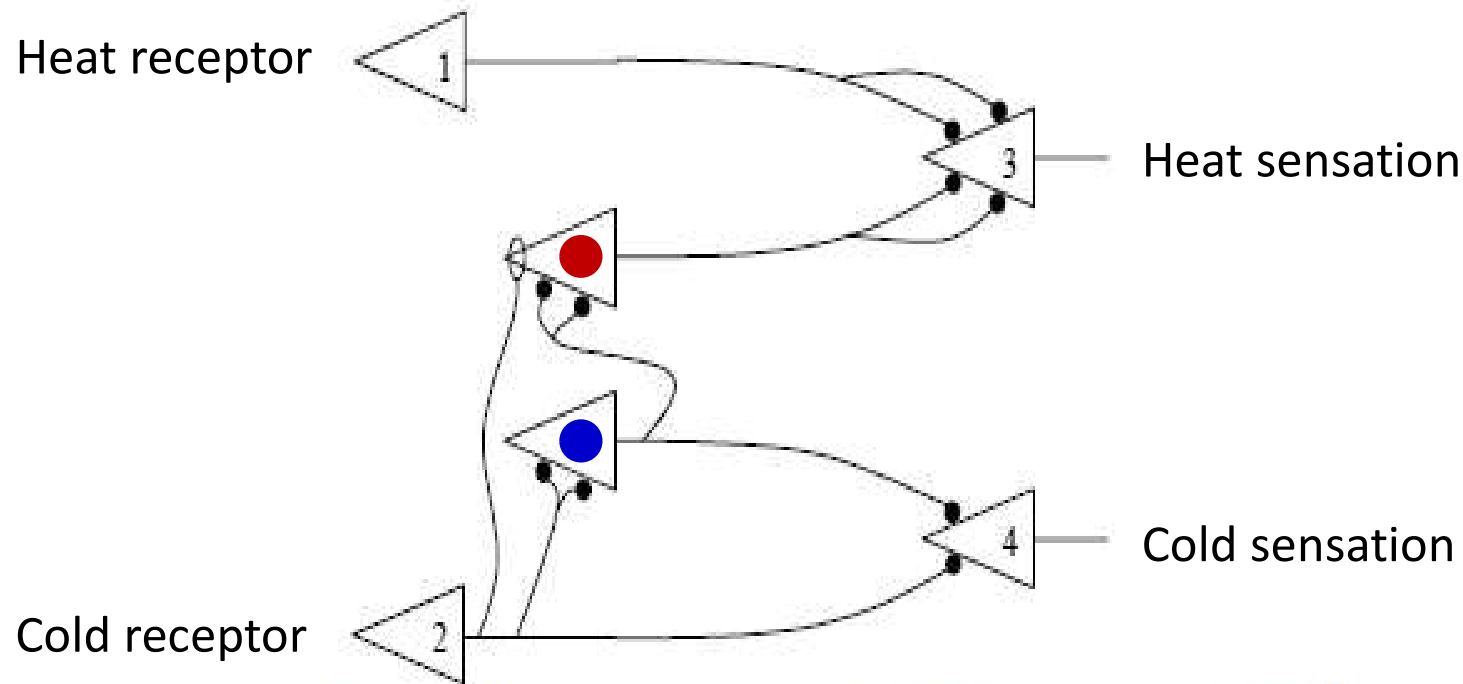
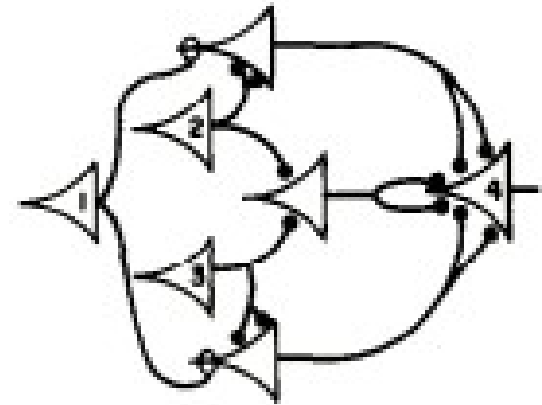

Figure 2. Net explaining the heat illusion. Neuron 3 (heat sensation) fires if and only if it receives two inputs, represented by the lines terminating on its body. This happens when either neuron 1 (heat reception) fires or neuron 2 (cold reception) fires once and then immediately stops firing. When neuron 2 fires twice in a row, the intermediate (unnumbered) neurons excite neuron 4 rather than neuron 3, generating a sensation of cold.

McCulloch and Pitts Model

- Could compute arbitrary Boolean propositions
 - Since any Boolean function can be emulated, any Boolean function can be composed



- Models for *memory*
 - Networks with loops can “remember”
 - We’ll see more of this later
 - Lawrence Kubie (1930): Closed loops in the central nervous system explain memory

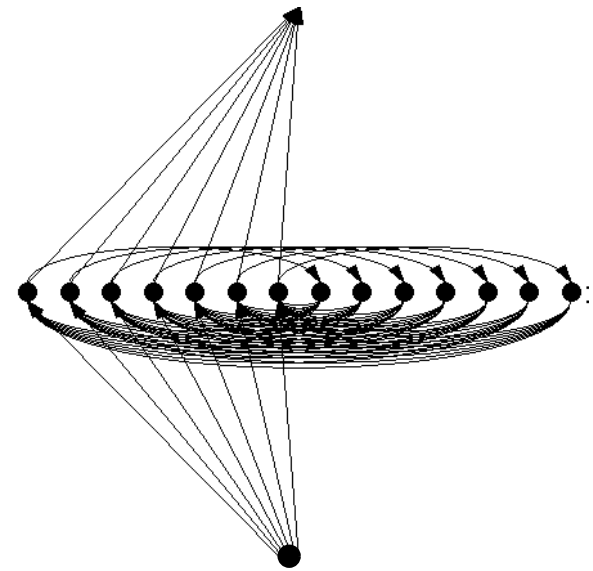

Criticisms

- They claimed that their nets
 - Should be able to compute a small class of functions
 - Also, if tape is provided their nets can compute a richer class of functions.
 - They will be equivalent to Turing machines
 - Claim that they're Turing complete
 - They didn't prove the results themselves
- Didn't provide a learning mechanism..

Donald Hebb

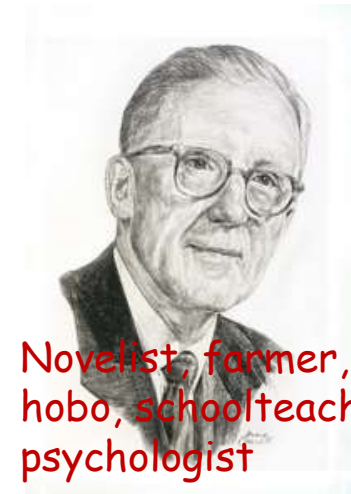

Novelist, farmer,
hobo, schoolteacher
psychologist

- “Organization of behavior”, 1949
- A learning mechanism:
 - “When an axon of cell *A* is near enough to excite a cell *B* and repeatedly or persistently takes part in firing it, some growth process or metabolic change takes place in one or both cells such that *A*'s efficiency, as one of the cells firing *B*, is increased.”
 - As *A* repeatedly excites *B*, its *ability* to excite *B* improves
 - *Neurons that fire together wire together*

Hebbian Learning

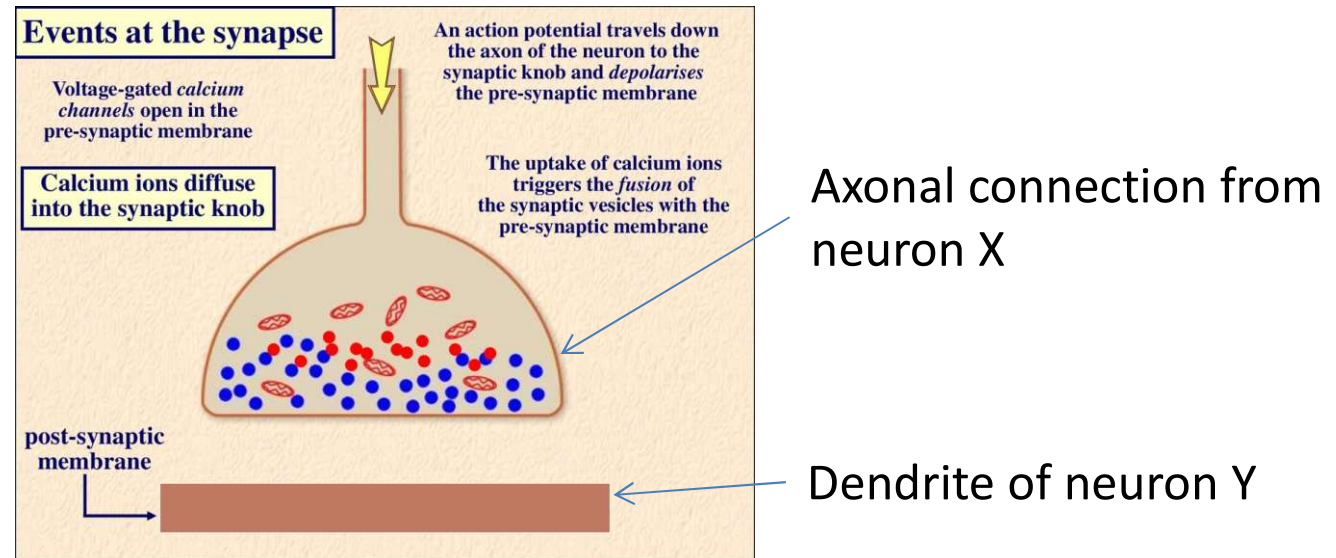

- If neuron x repeatedly triggers neuron y , the synaptic knob connecting x to y gets larger
- In a mathematical model:

$$w_{xy} = w_{xy} + \eta xy$$

- Weight of the connection from input neuron x to output neuron y
- This simple formula is actually the basis of many learning algorithms in ML

Hebbian Learning

- **Fundamentally unstable**
 - Stronger connections will enforce themselves
 - No notion of “competition”
 - No *reduction* in weights
 - Learning is unbounded
- Number of later modifications, allowing for weight normalization, forgetting etc.
 - E.g. Generalized Hebbian learning, aka Sanger’s rule

$$w_{ij} = w_{ij} + \eta y_j \left(x_i - \sum_{k=1}^j w_{ik} y_k \right)$$

- The contribution of an input is incrementally *distributed* over multiple outputs..

Poll 2

Hebbian learning is... (Single Choice)

- Fundamentally stable since stronger connections will enforce themselves
- Fundamentally unstable since there is no reduction in weights
- Fundamentally stable since learning is unbounded
- Fundamentally unstable since weights compete for adjustment

Poll 2

Hebbian learning is... (Single Choice)

- Fundamentally stable since stronger connections will enforce themselves
- **Fundamentally unstable since there is no reduction in weights**
- Fundamentally stable since learning is unbounded
- Fundamentally unstable since weights compete for adjustment

A better model



- Frank Rosenblatt
 - Psychologist, Logician
 - Inventor of the solution to everything, aka the Perceptron (1958)

Rosenblatt's perceptron

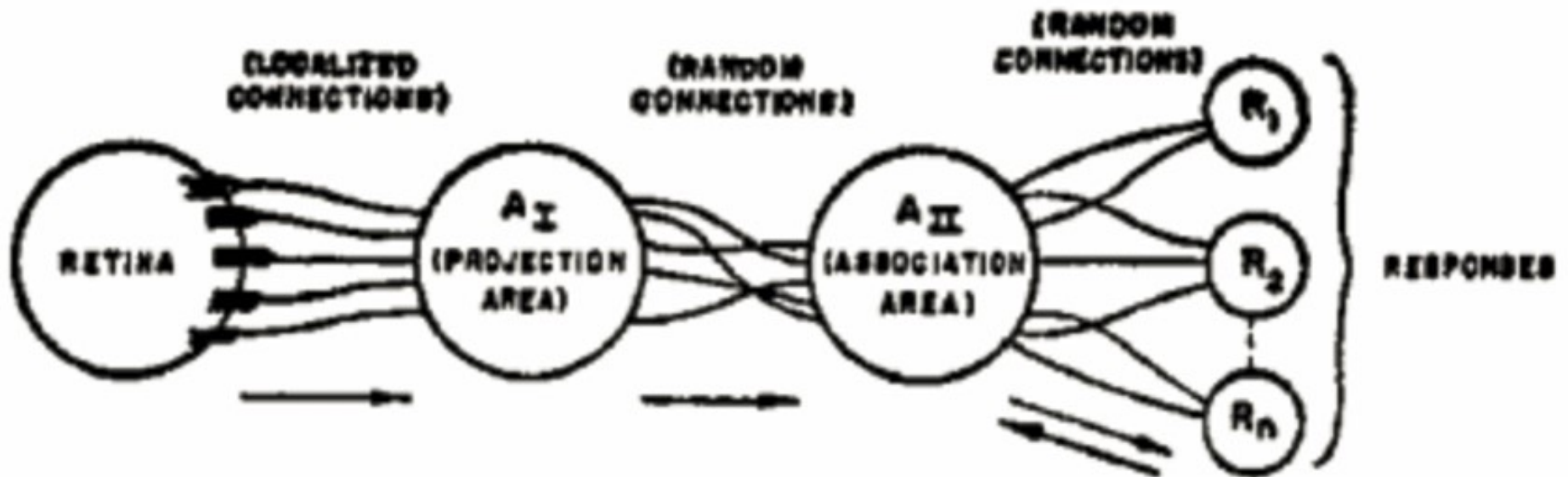

- Original perceptron model
 - Groups of sensors (S) on retina combine onto cells in association area A₁
 - Groups of A₁ cells combine into Association cells A₂
 - Signals from A₂ cells combine into response cells R
 - All connections may be excitatory or inhibitory

Rosenblatt's perceptron

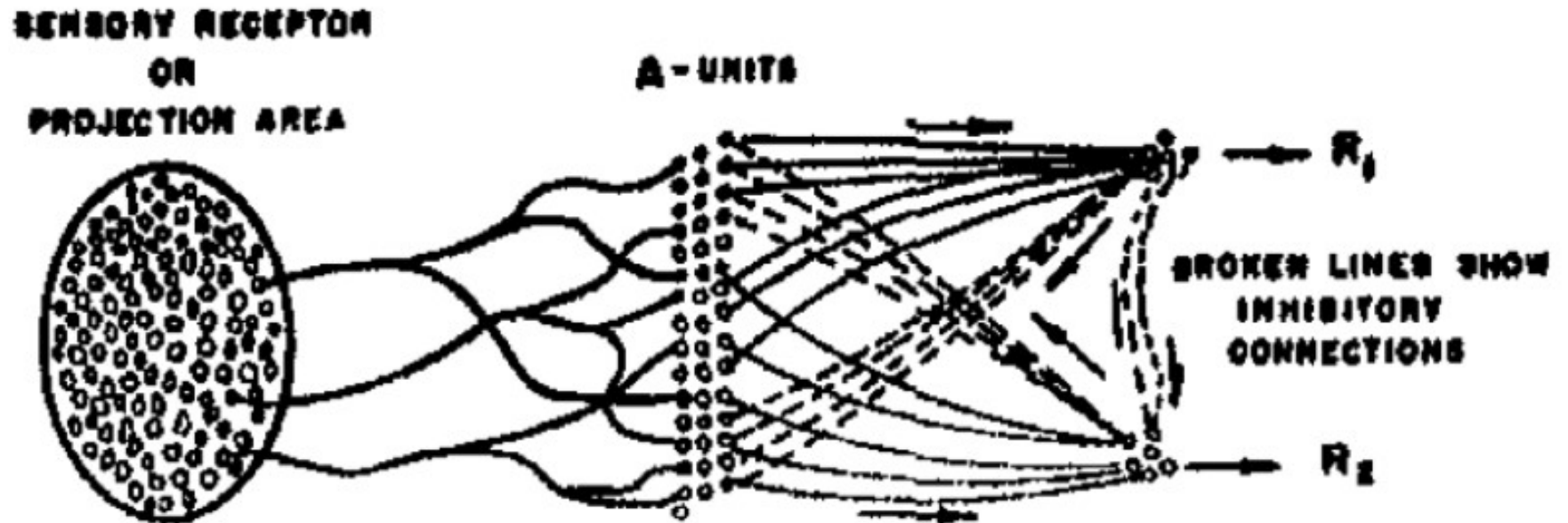

- Even included feedback between A and R cells
 - Ensures mutually exclusive outputs

Rosenblatt's perceptron

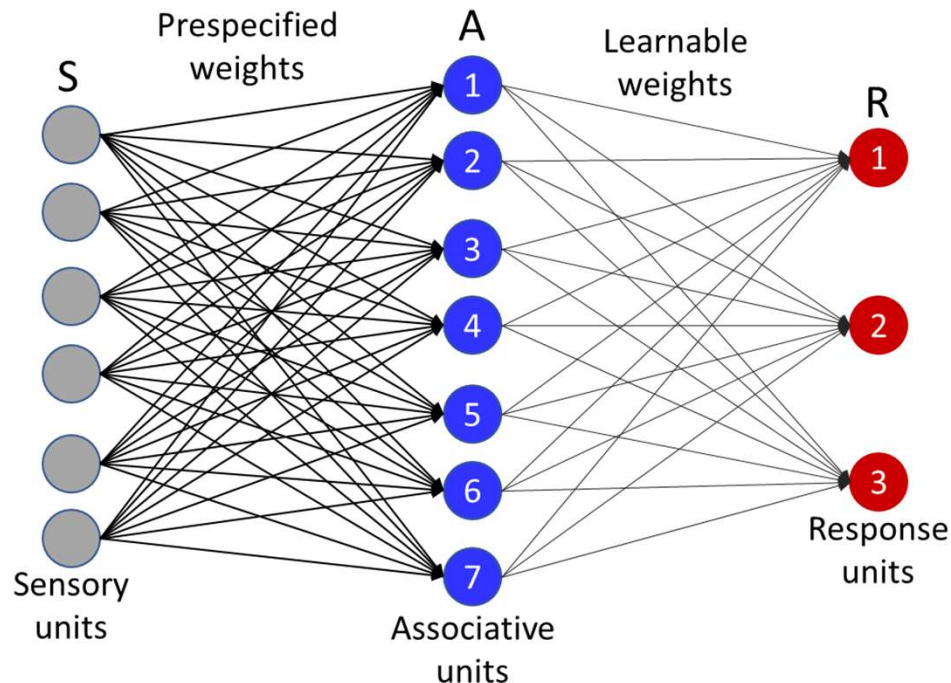

- Simplified perceptron model
 - Association units combine sensory input with fixed weights
 - Response units combine associative units with learnable weights

Perceptron: Simplified model

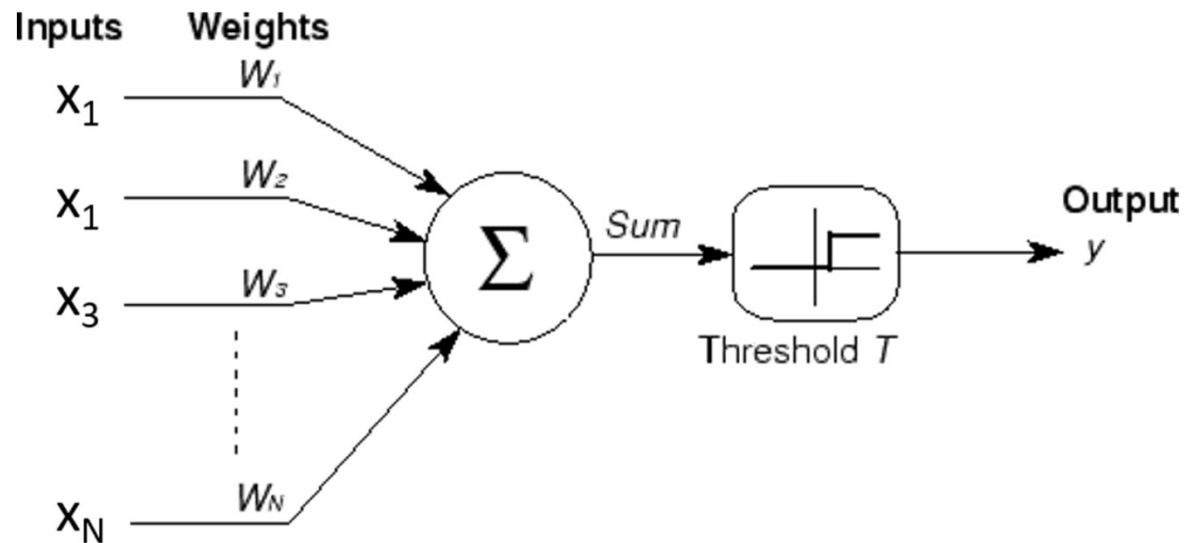

- Number of inputs combine linearly
 - Threshold logic: Fire if combined input exceeds threshold

$$Y = \begin{cases} 1 & \text{if } \sum_i w_i x_i - T \geq 0 \\ 0 & \text{else} \end{cases}$$

The Universal Model

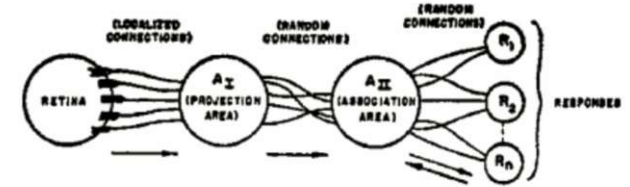

- Originally assumed could represent *any* Boolean circuit and perform any logic
 - “*the embryo of an electronic computer that [the Navy] expects will be able to walk, talk, see, write, reproduce itself and be conscious of its existence,*” New York Times (8 July) 1958
 - “*Frankenstein Monster Designed by Navy That Thinks,*” Tulsa, Oklahoma Times 1958

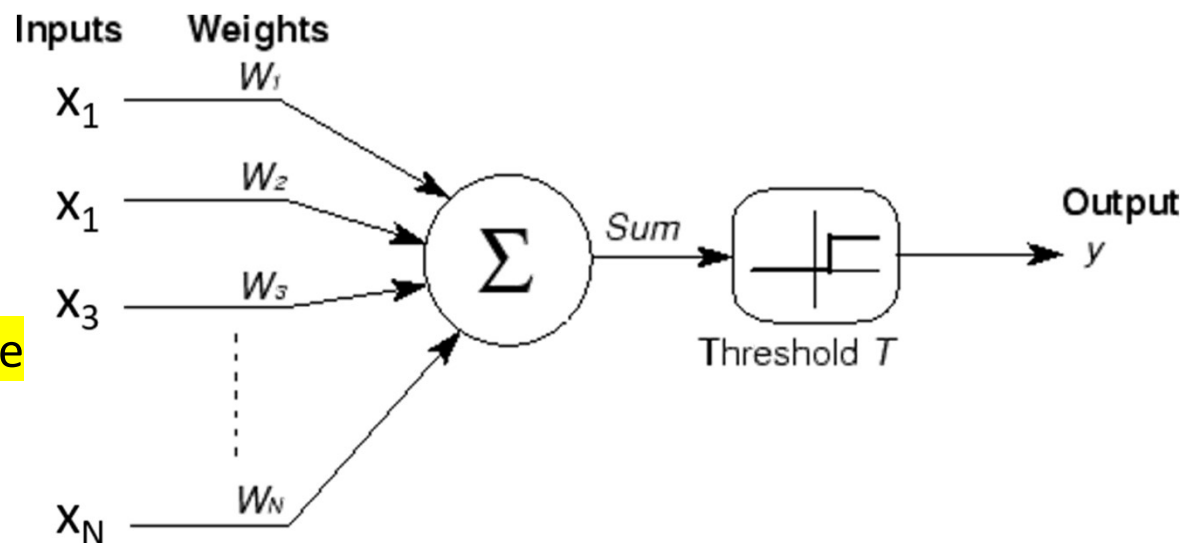

Holds vaguely true of the original model, but assumed true of even the simplified model.

Also provided a learning algorithm

$$\mathbf{w} = \mathbf{w} + \eta(d(\mathbf{x}) - y(\mathbf{x}))\mathbf{x}$$

Sequential Learning:

$d(x)$ is the desired output in response to input \mathbf{x}

$y(x)$ is the actual output in response to \mathbf{x}

- Boolean tasks
- Update the weights whenever the perceptron output is wrong
 - Update the weight by the product of the input and the *error* between the desired and actual outputs
- Proved convergence for linearly separable classes

Perceptron

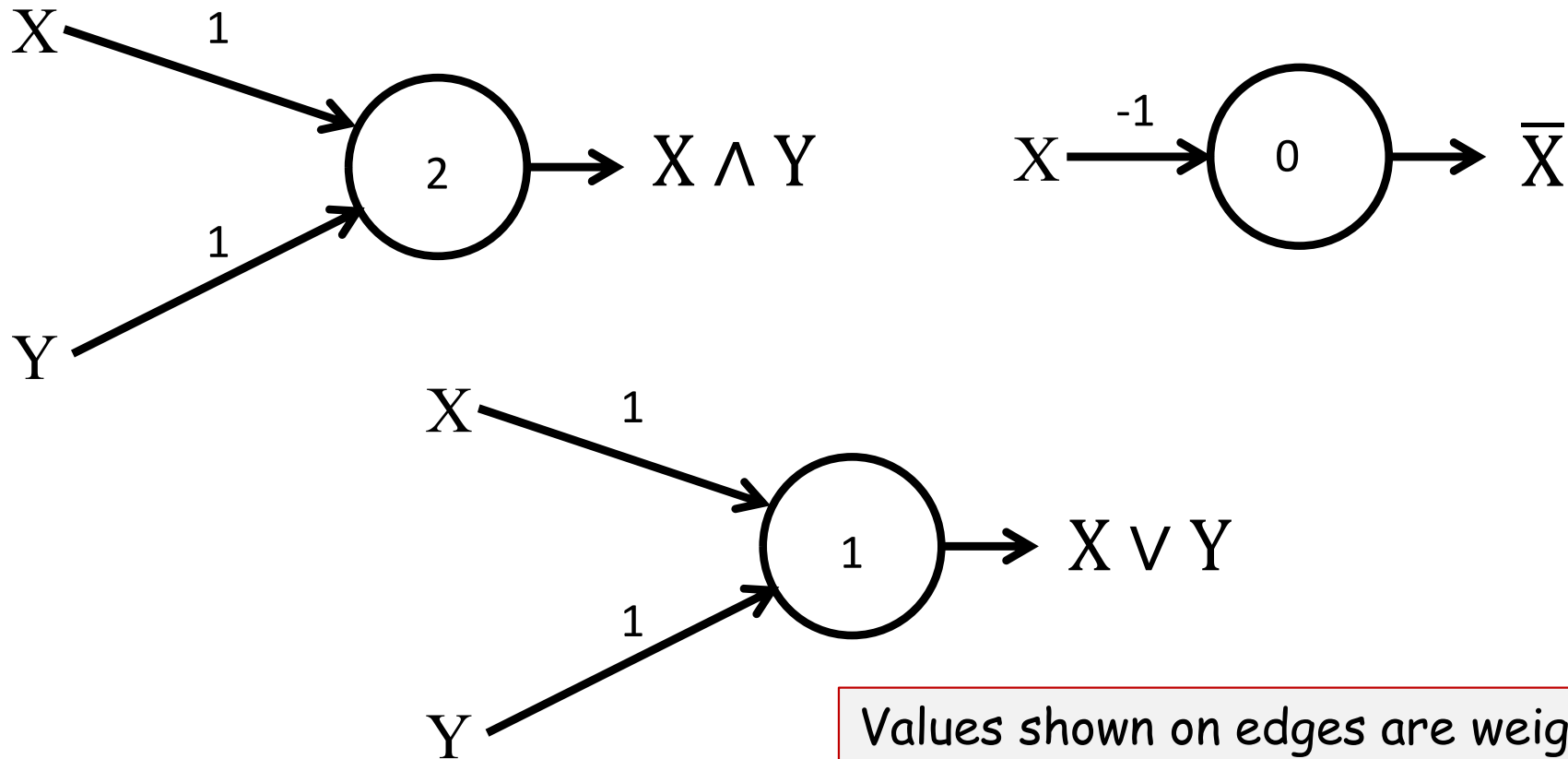

Values shown on edges are weights, numbers in the circles are thresholds

- Easily shown to mimic any Boolean gate
- But...

Individual units

No solution for XOR!

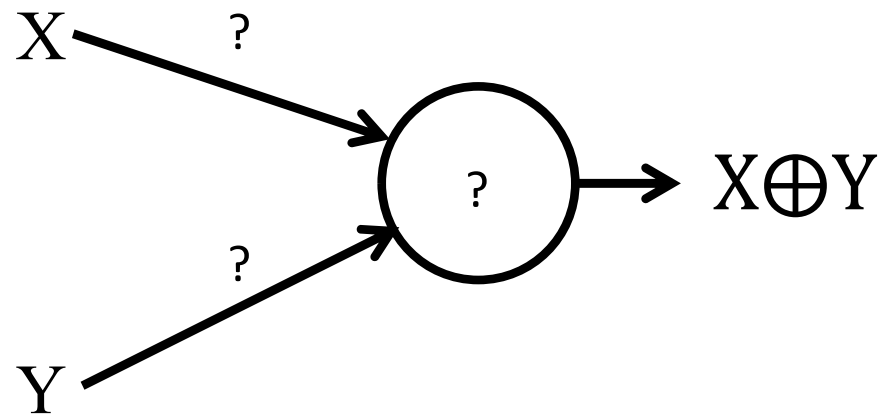

A single neuron is not enough

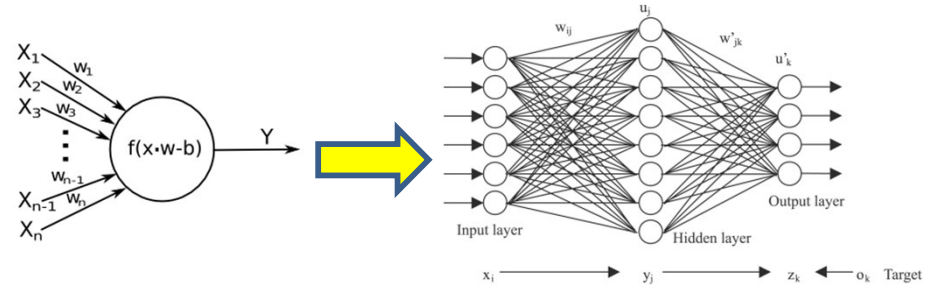
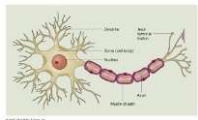

- Individual elements are weak computational elements
 - Marvin Minsky and Seymour Papert, 1969, *Perceptrons: An Introduction to Computational Geometry*
- *Networked* elements are required

Multi-layer Perceptron!

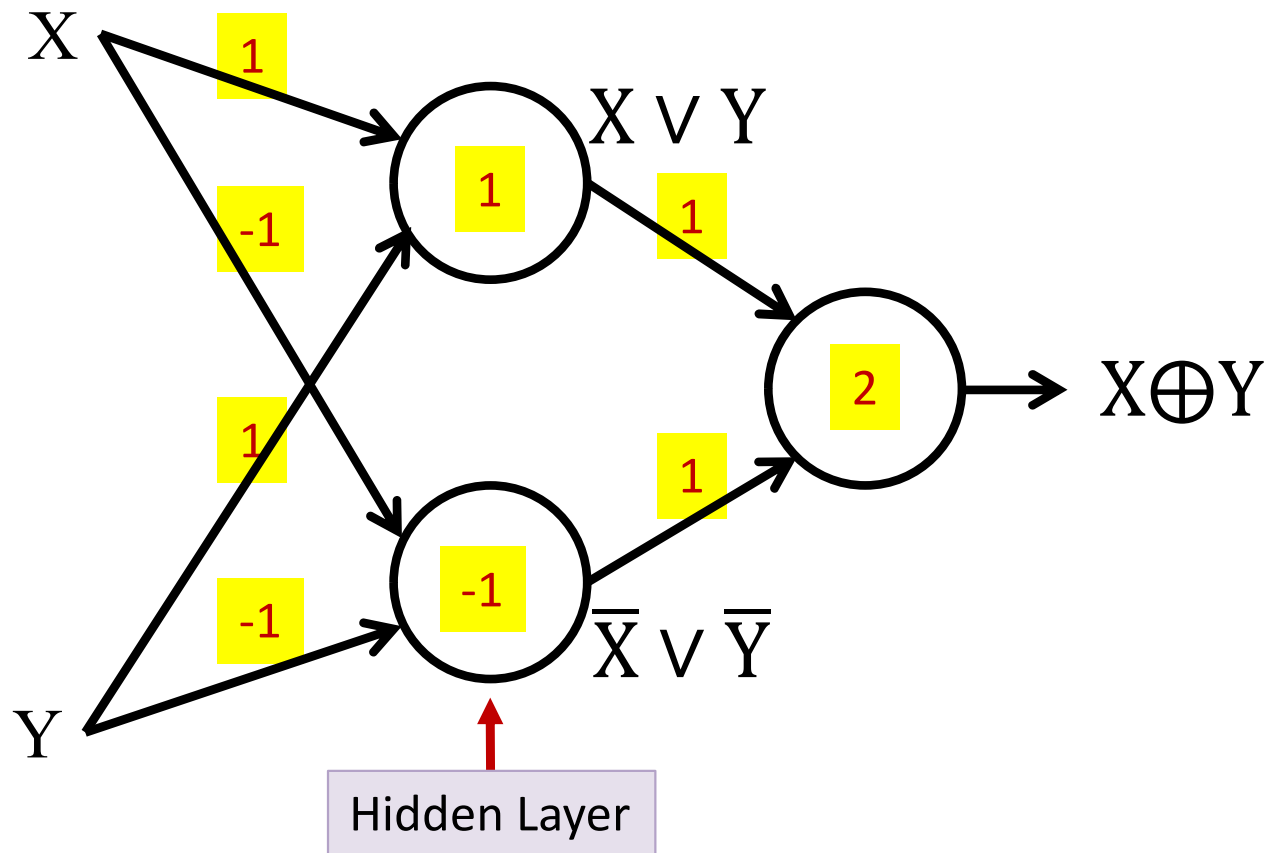

- **XOR**

- The first layer is a “hidden” layer

A more generic model

$$((A \& \bar{X} \& Z) | (A \& \bar{Y})) \& ((X \& Y) | \overline{(X \& Z)})$$

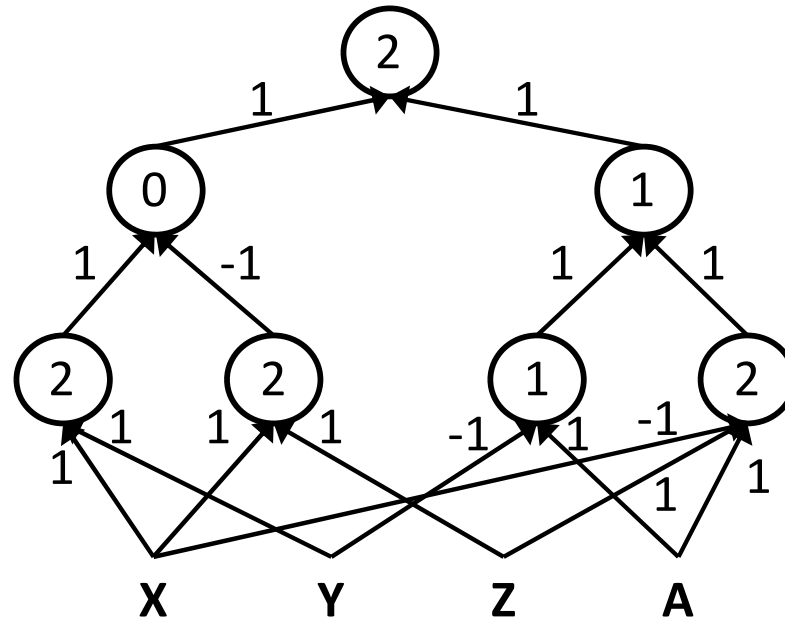

- A “multi-layer” perceptron
- Can compose arbitrarily complicated Boolean functions!
 - In cognitive terms: Can compute arbitrary Boolean functions over sensory input
 - More on this in the next class

Story so far

- Neural networks began as computational models of the brain
- Neural network models are *connectionist machines*
 - They comprise networks of neural units
- McCulloch and Pitt model: Neurons as Boolean threshold units
 - Models the brain as performing propositional logic
 - But no learning rule
- Hebb's learning rule: Neurons that fire together wire together
 - Unstable
- Rosenblatt's perceptron : A variant of the McCulloch and Pitt neuron with a provably convergent learning rule
 - But individual units are limited in their capacity
- Multi-layer perceptrons can model arbitrarily complex Boolean functions

But our brain is not Boolean

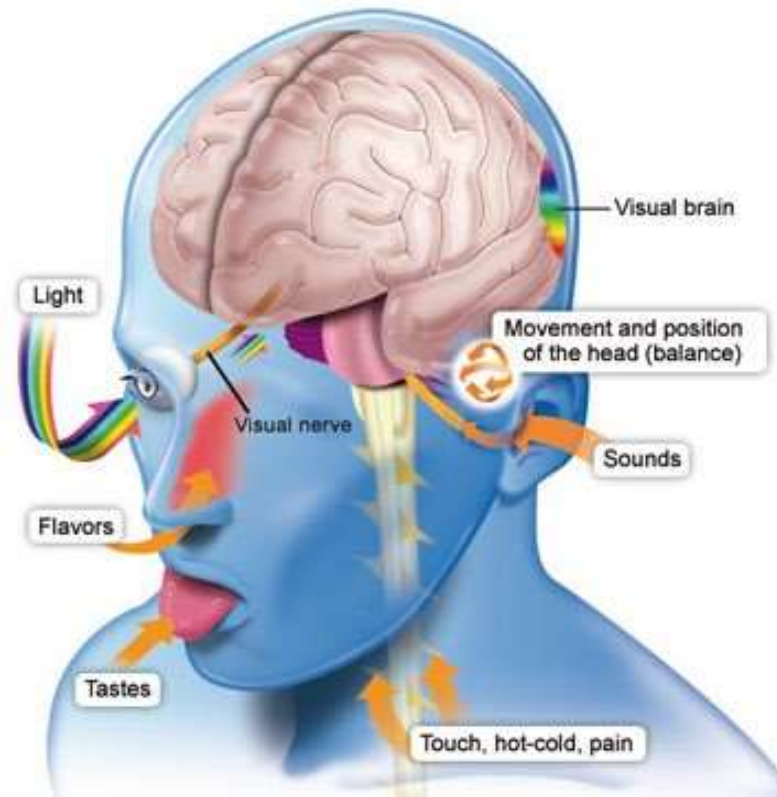

- We have real inputs
- We make non-Boolean inferences/predictions

The perceptron with *real* inputs

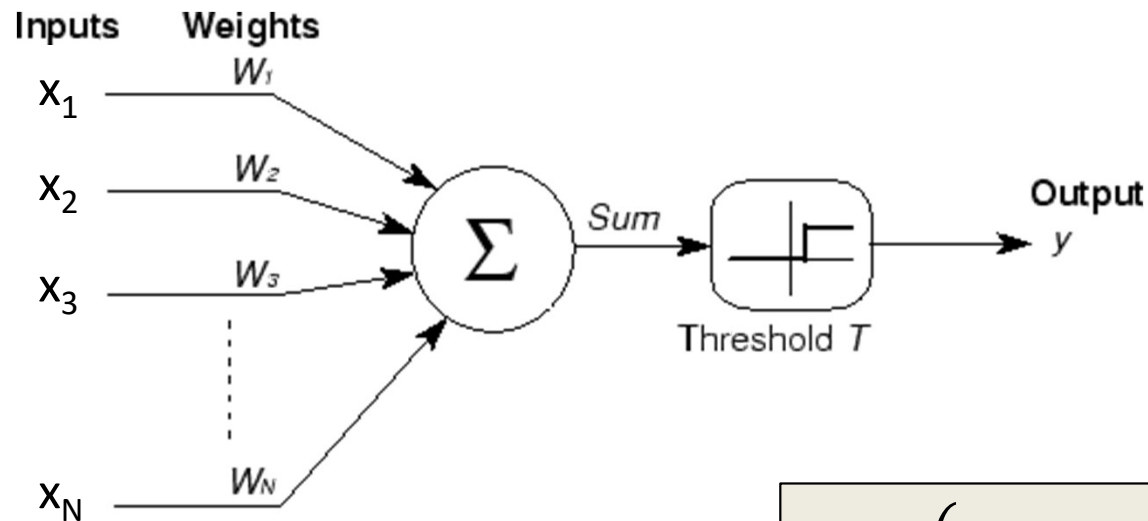

$$y = \begin{cases} 1 & \text{if } \sum_i w_i x_i - T \geq 0 \\ 0 & \text{else} \end{cases}$$

- $x_1 \dots x_N$ are real valued
- $w_1 \dots w_N$ are real valued
- Unit “fires” if weighted input matches (or exceeds) a threshold

The perceptron with *real* inputs

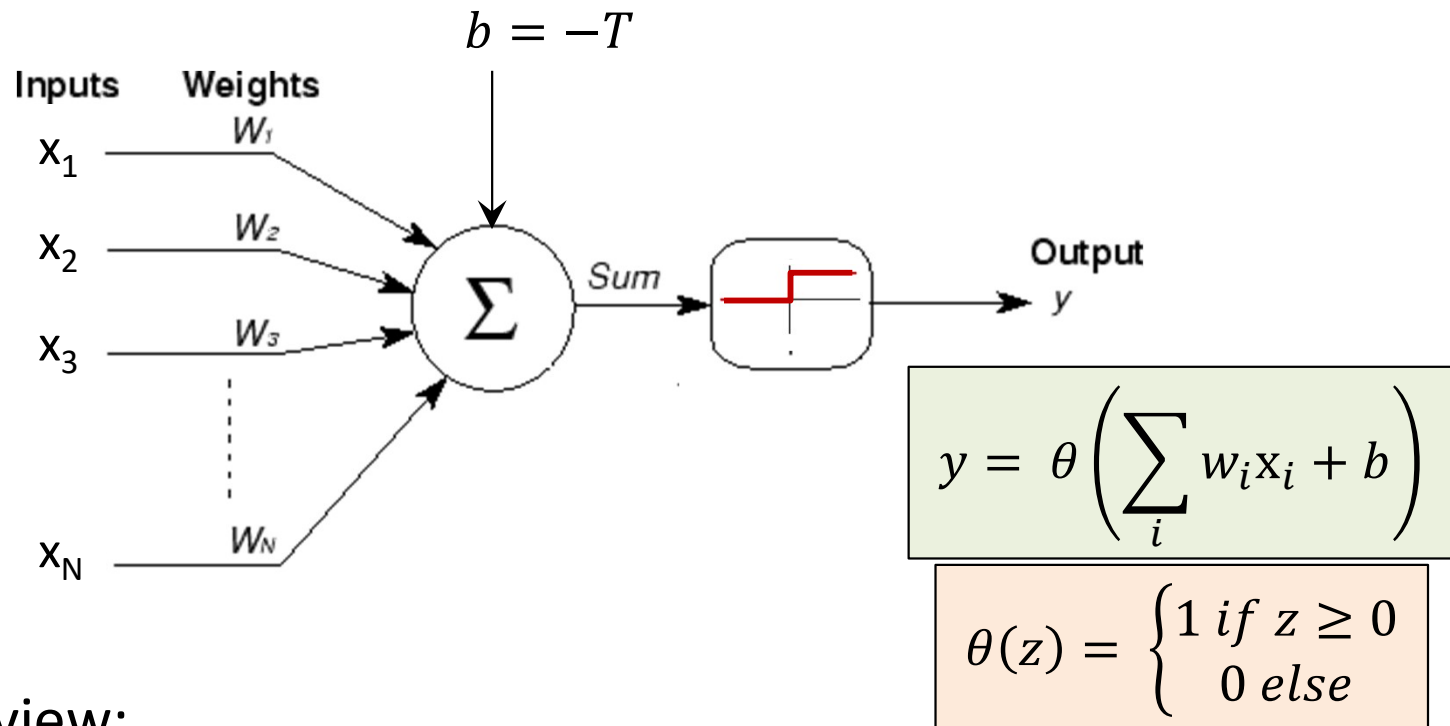

- Alternate view:
 - A threshold “activation” $\theta(z)$ operates on the weighted sum of inputs plus a bias
 - An *affine* function of the inputs
 - $\theta(z)$ outputs a 1 if z is non-negative, 0 otherwise
- Unit “fires” if weighted input matches or exceeds a threshold

The perceptron with *real* inputs

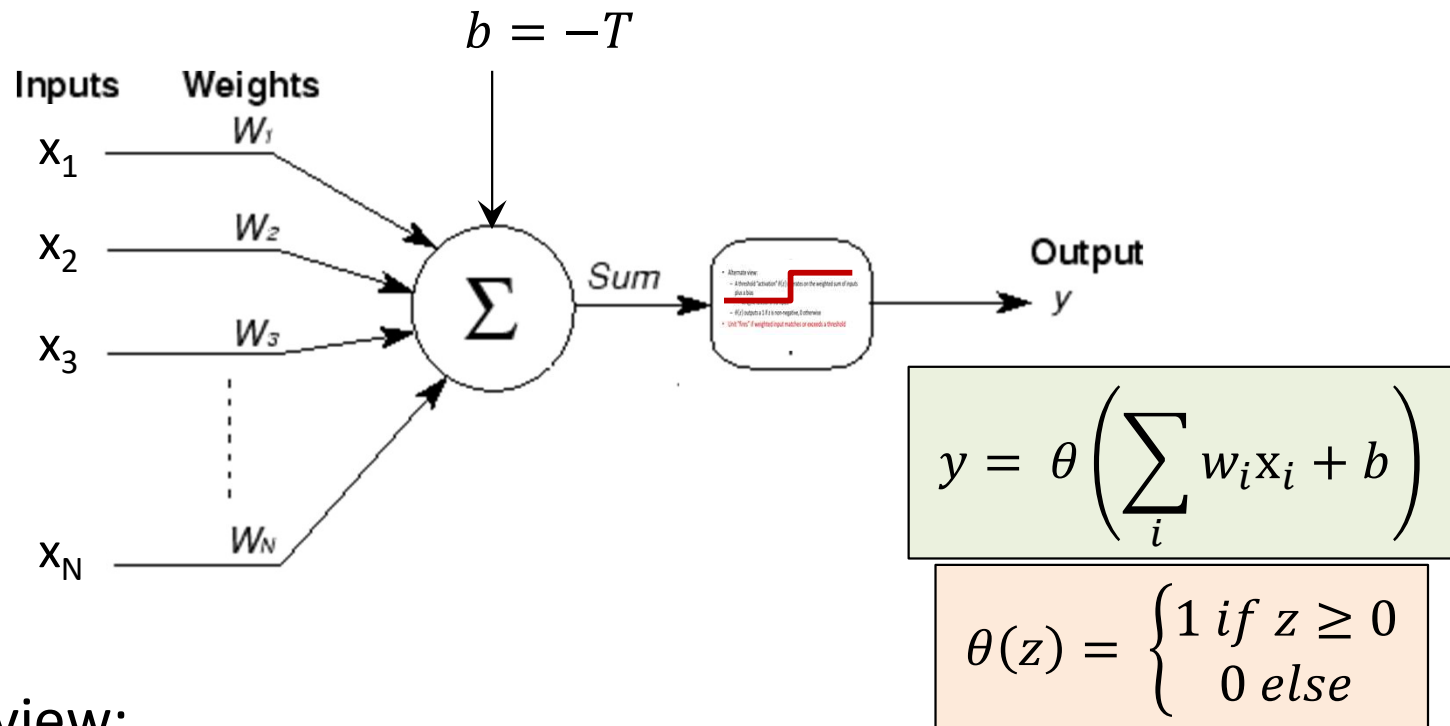

- Alternate view:
 - A threshold “activation” $\theta(z)$ operates on the weighted sum of inputs plus a bias
 - An *affine* function of the inputs → **What is the difference between “linear” and “affine”?**
 - $\theta(z)$ outputs a 1 if z is non-negative, 0 otherwise
- **Unit “fires” if weighted input matches or exceeds a threshold**

The perceptron with *real* inputs and a *real output*

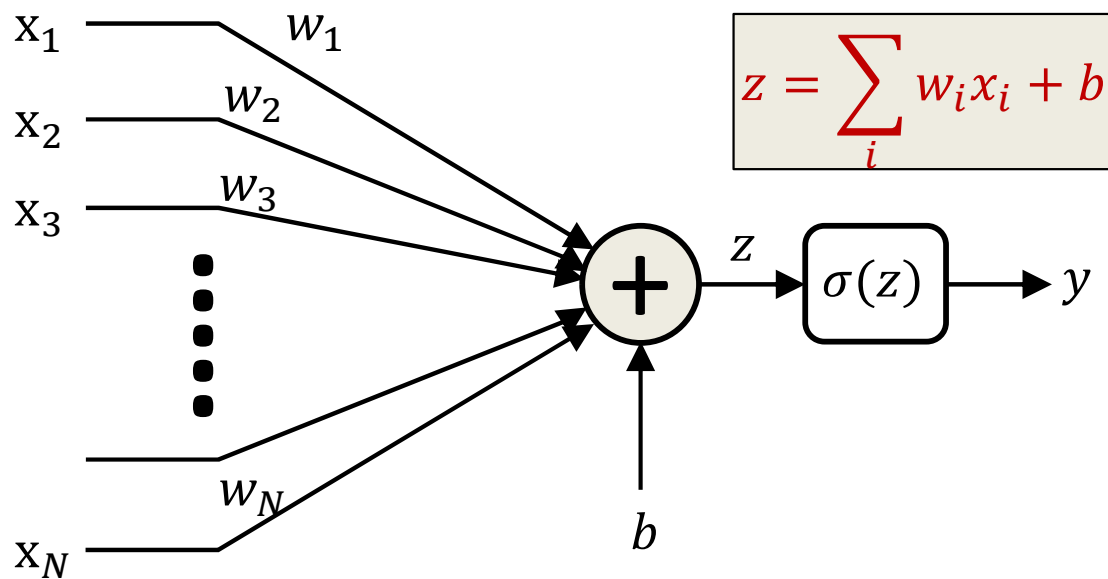

$$z = \sum_i w_i x_i + b$$

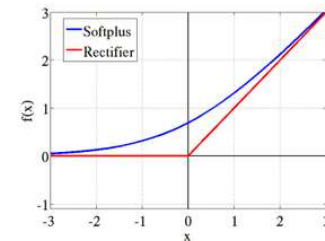
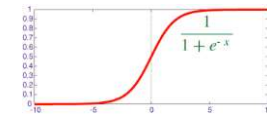
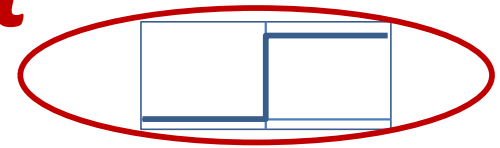

Activation functions $\sigma(z)$

- $x_1 \dots x_N$ are real valued
- $w_1 \dots w_N$ are real valued
- The output y can also be real valued
- *For now we will continue to assume threshold activations*

A Perceptron on Reals

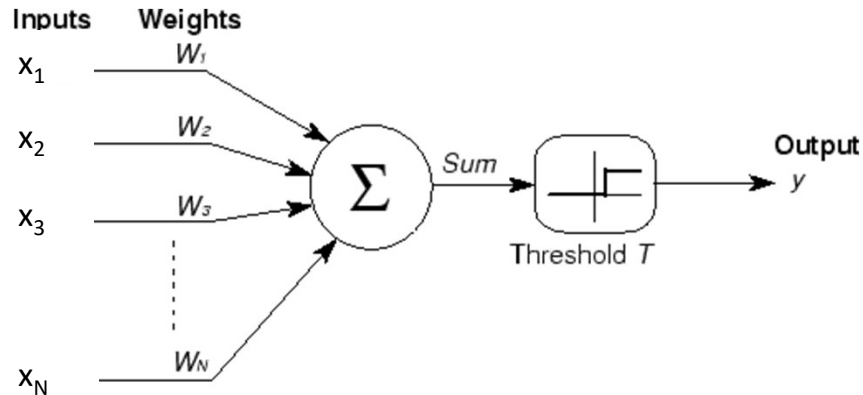

$$y = \begin{cases} 1 & \text{if } \sum_i w_i x_i \geq T \\ 0 & \text{else} \end{cases}$$

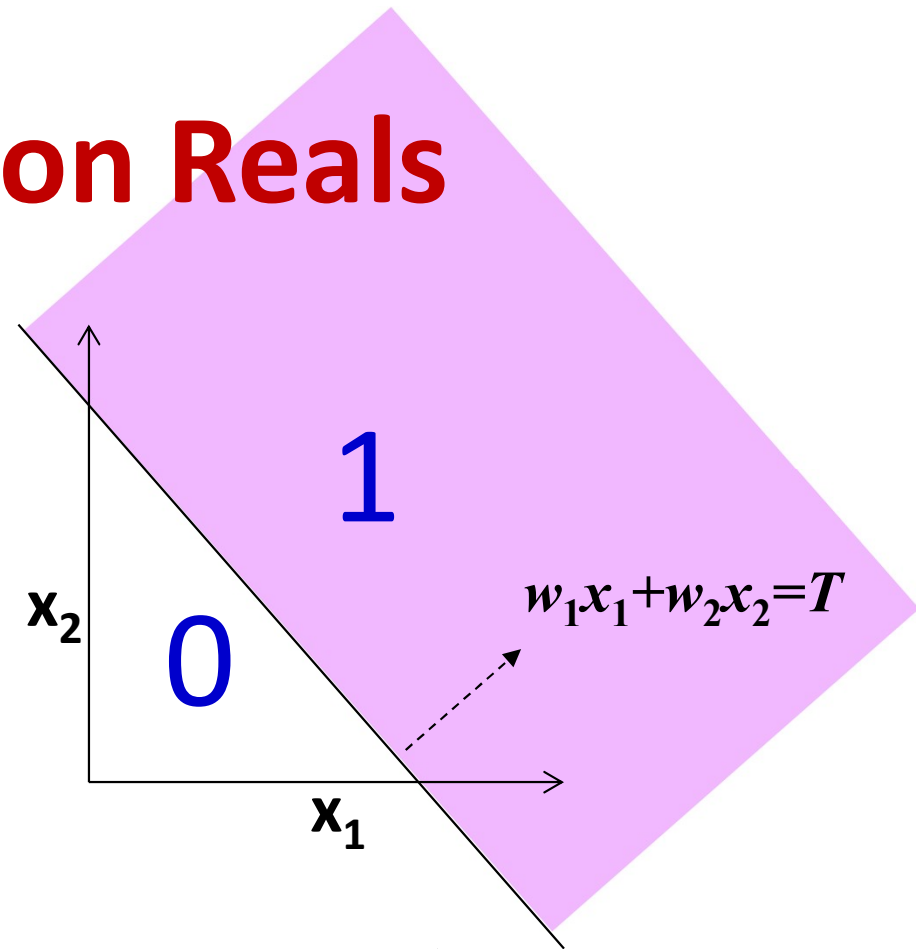

- A perceptron operates on *real-valued* vectors

– This is a *linear classifier*

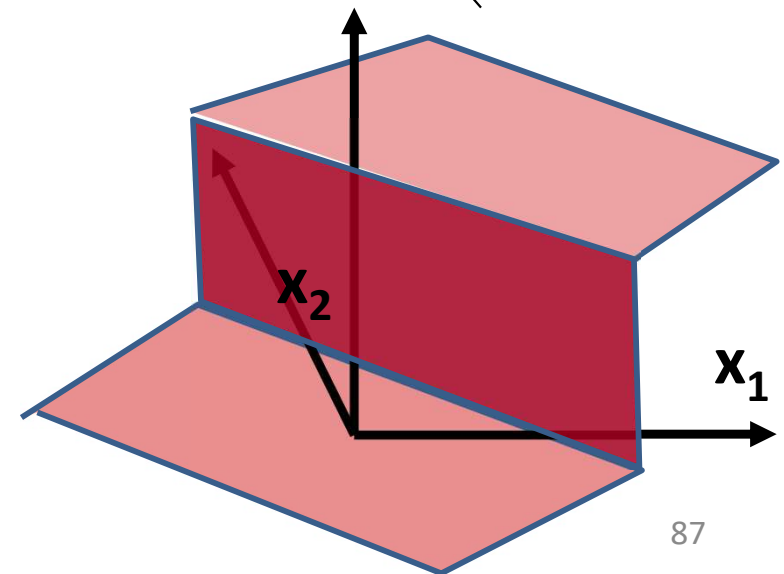

Boolean functions with a real perceptron

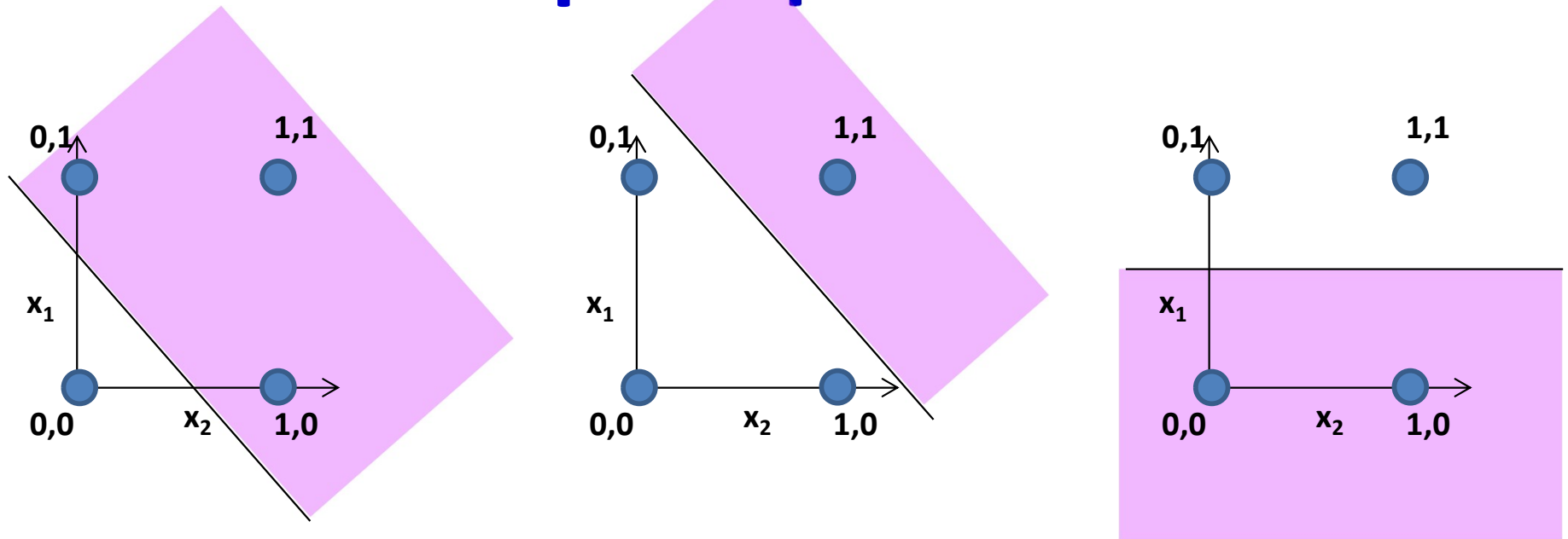

- Boolean perceptrons are also linear classifiers
 - Purple regions have output 1 in the figures
 - What are these functions
 - Why can we not compose an XOR?

Composing complicated “decision” boundaries

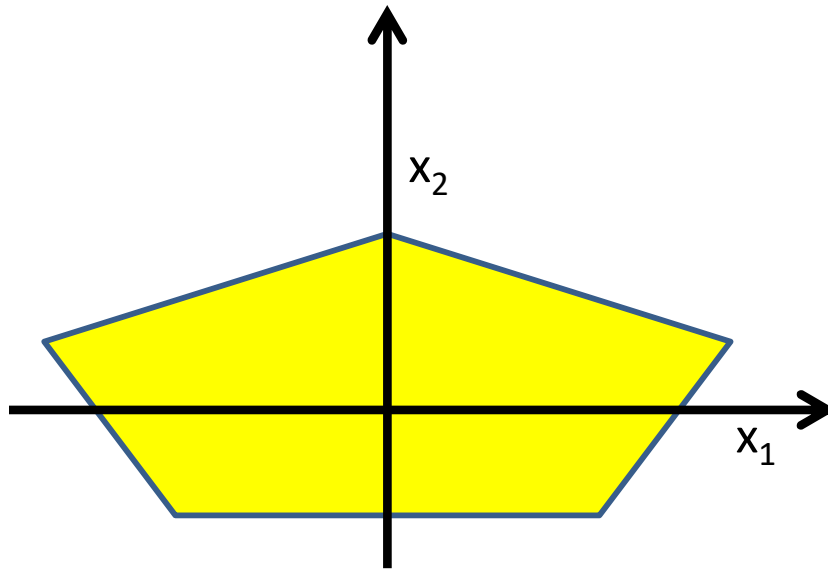

Can now be composed into “networks” to compute arbitrary classification “boundaries”

- Build a network of units with a single output that fires if the input is in the coloured area

Booleans over the reals

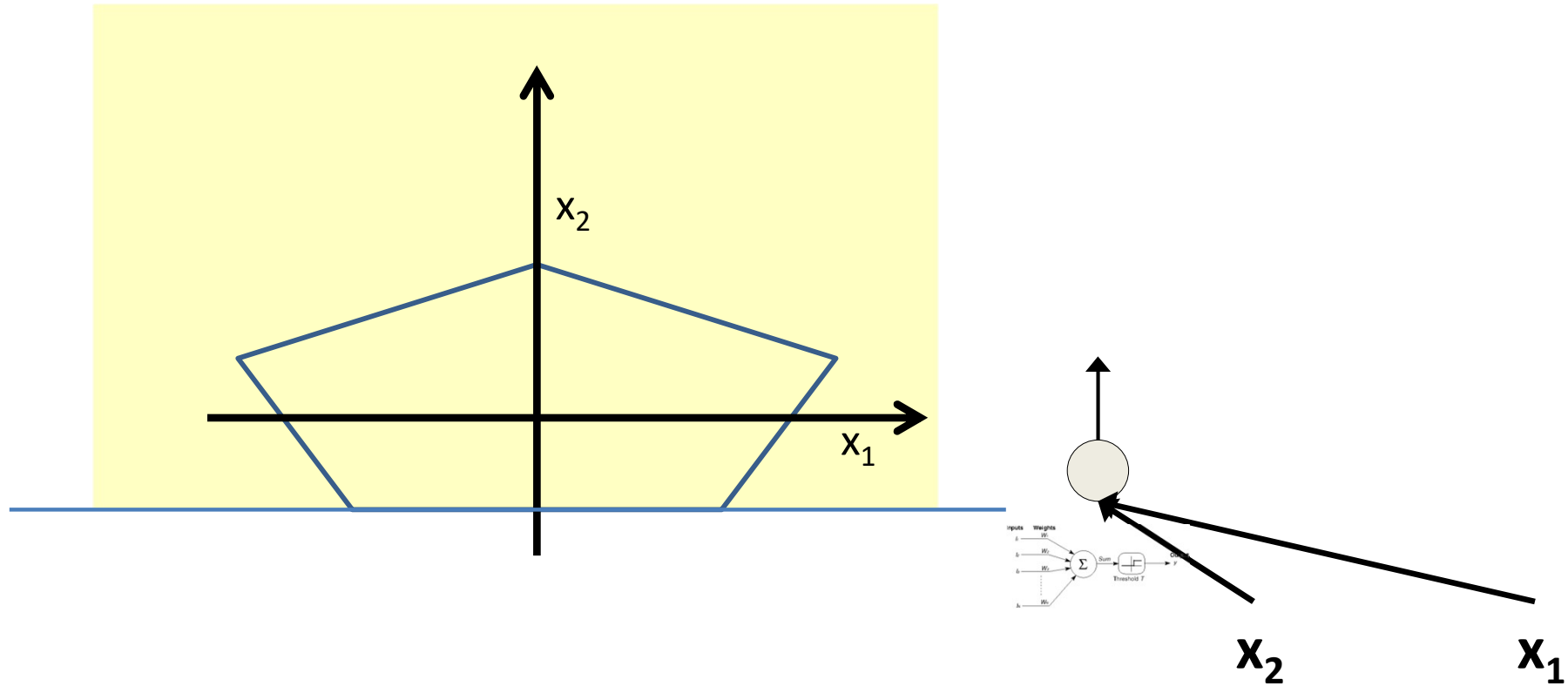

- The network must fire if the input is in the coloured area

Booleans over the reals

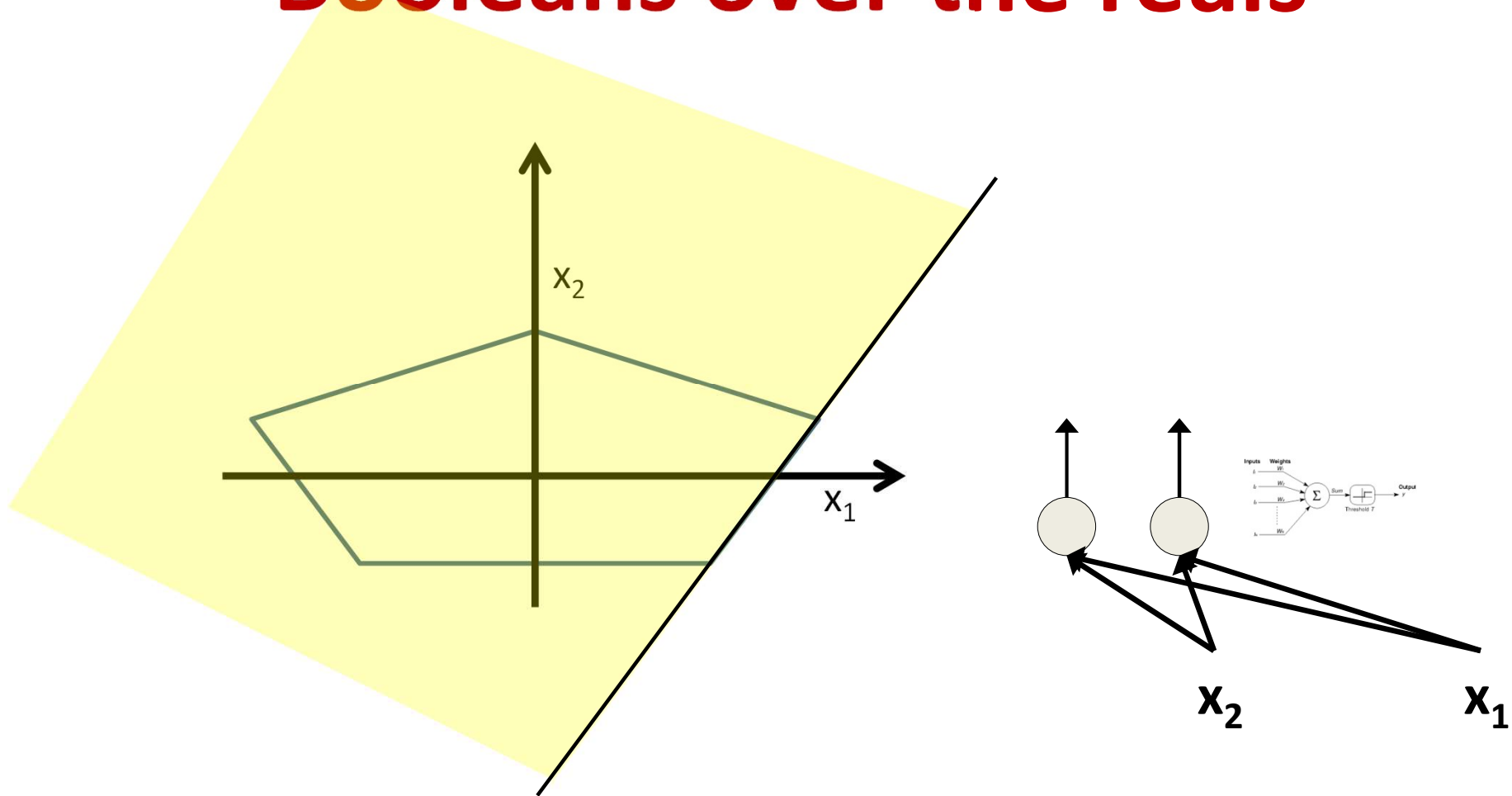

- The network must fire if the input is in the coloured area

Booleans over the reals

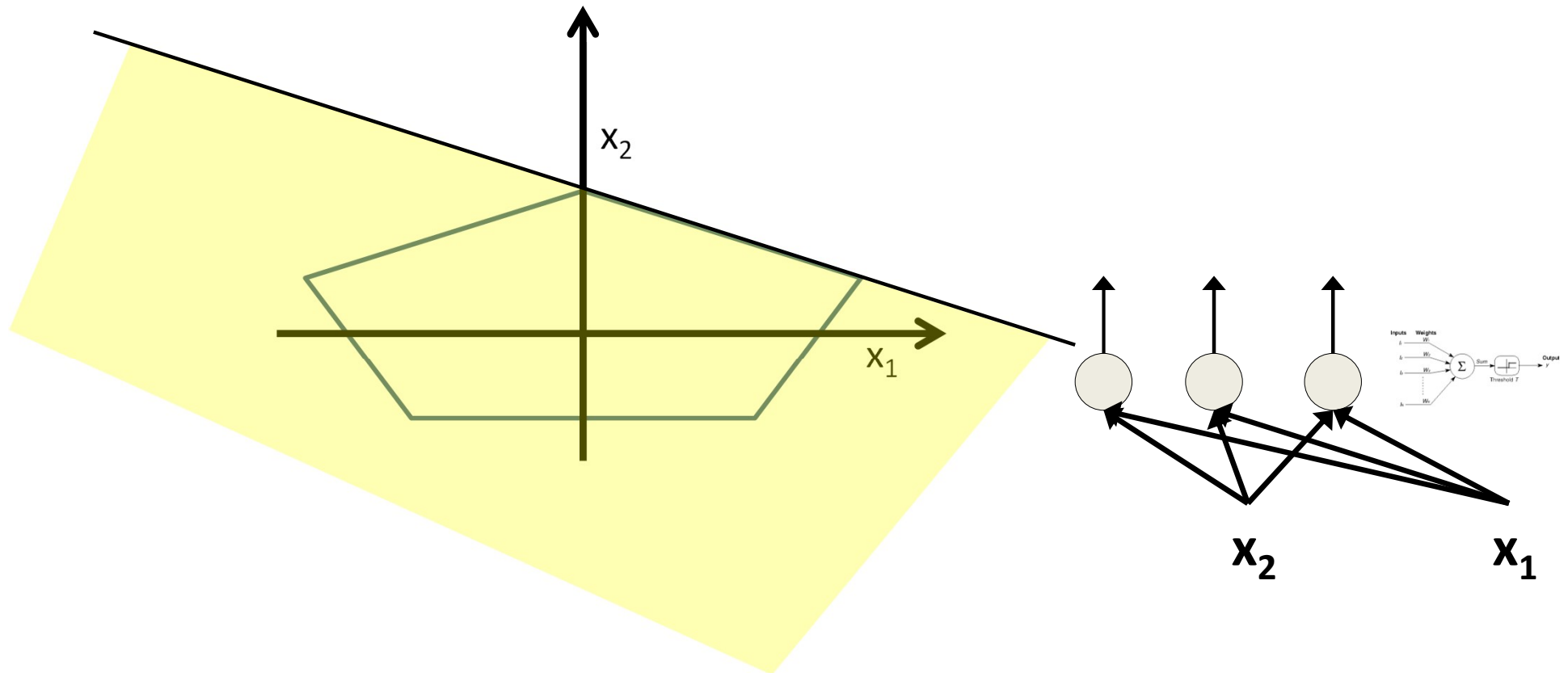

- The network must fire if the input is in the coloured area

Booleans over the reals

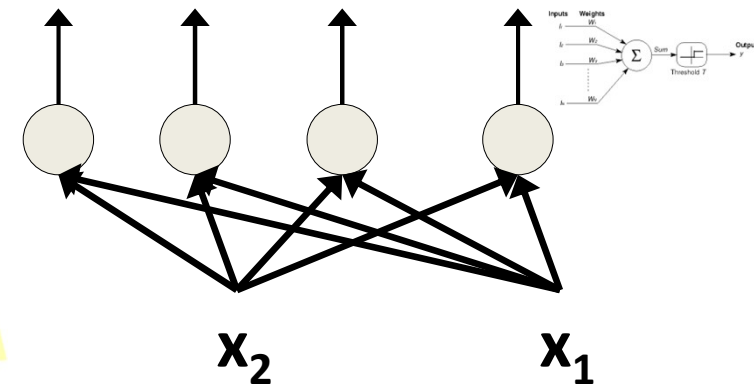
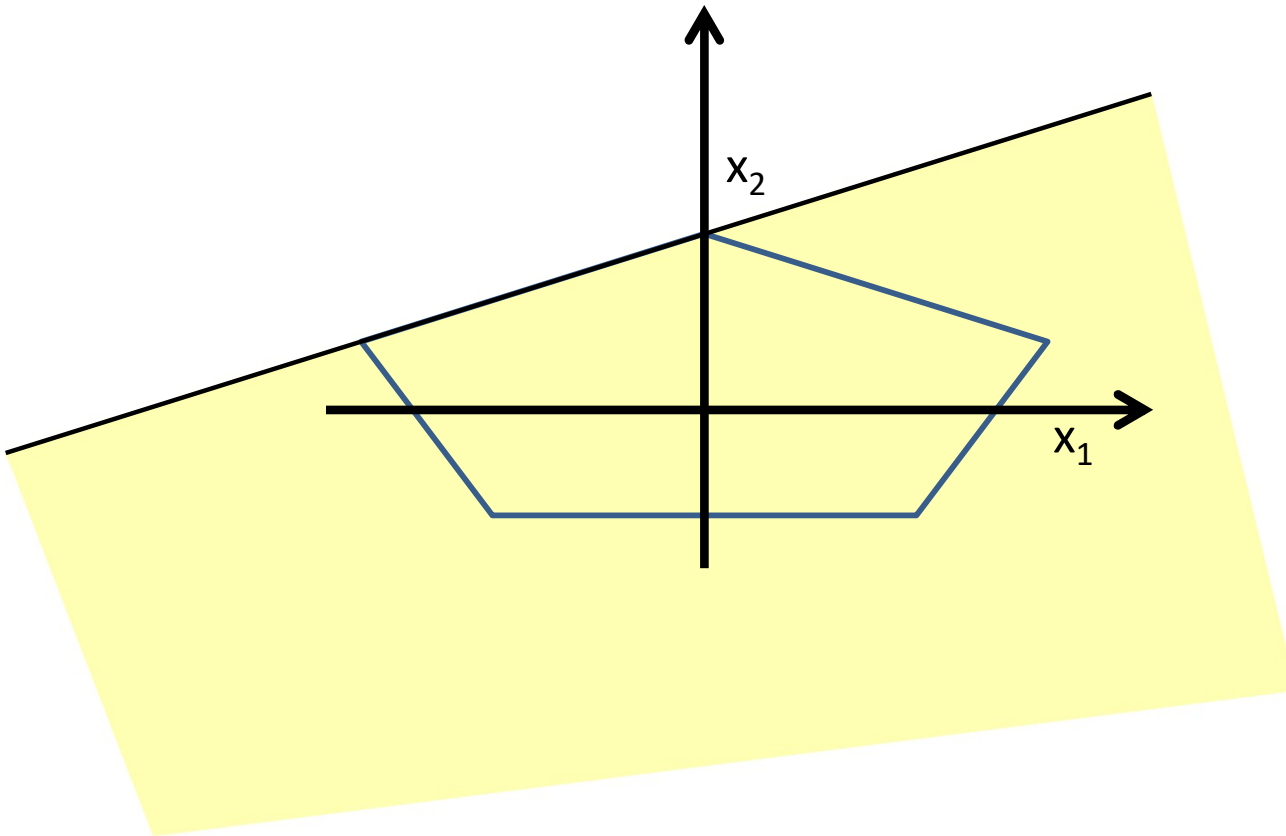

- The network must fire if the input is in the coloured area

Booleans over the reals

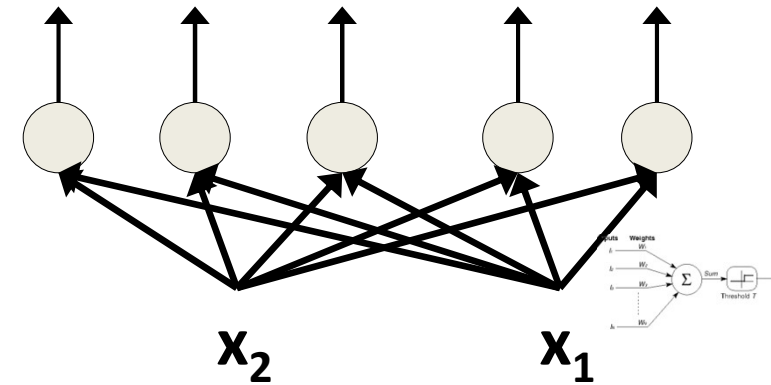
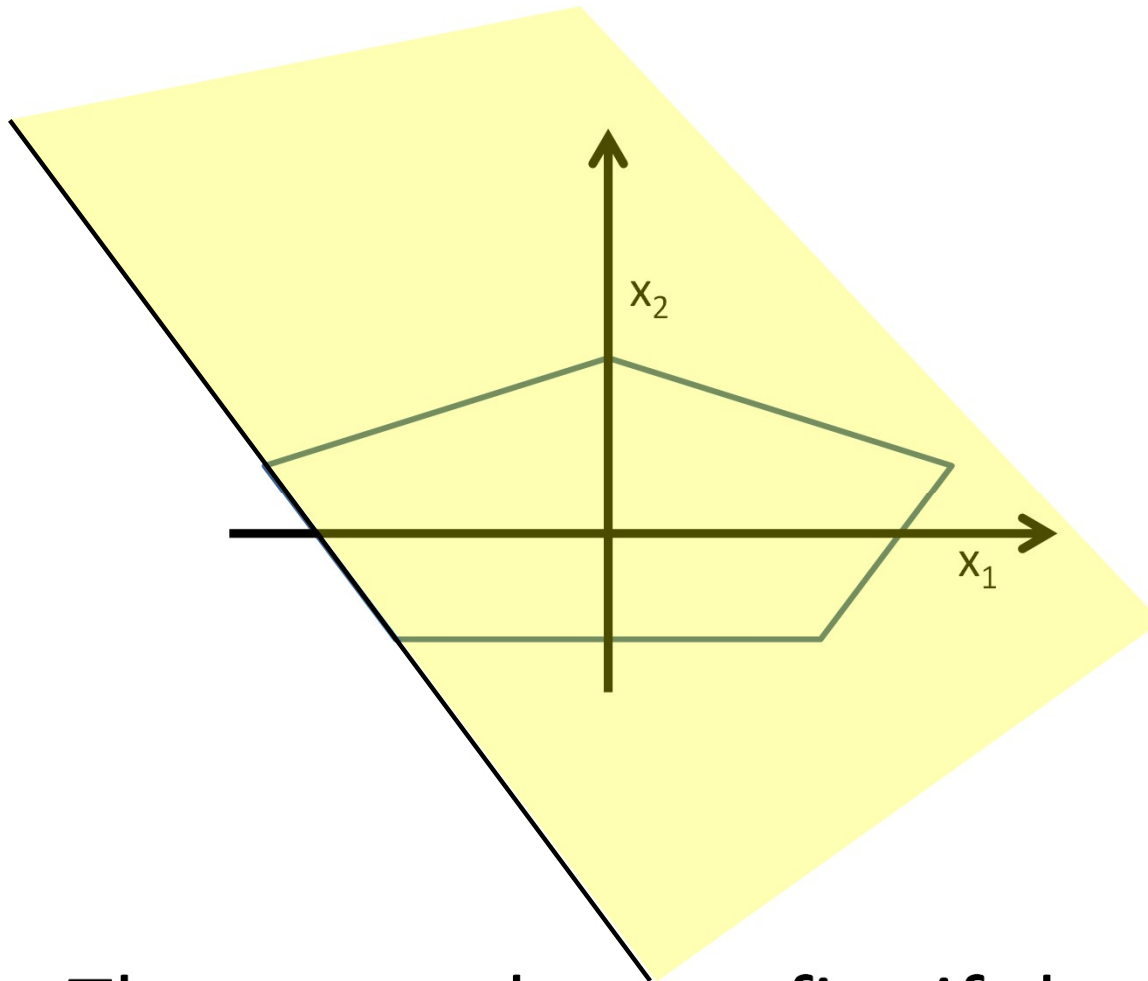

- The network must fire if the input is in the coloured area

Booleans over the reals

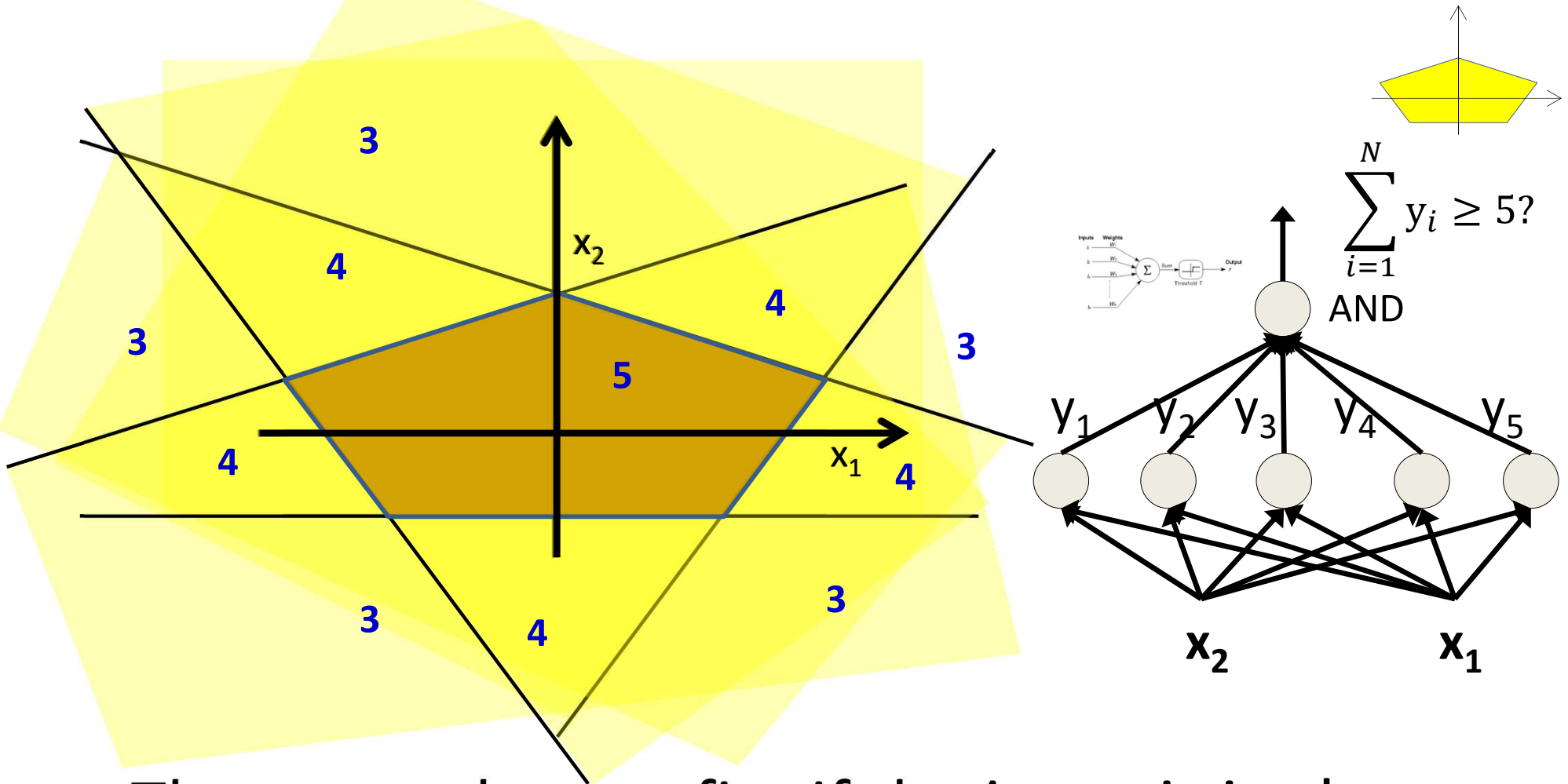

- The network must fire if the input is in the coloured area

More complex decision boundaries

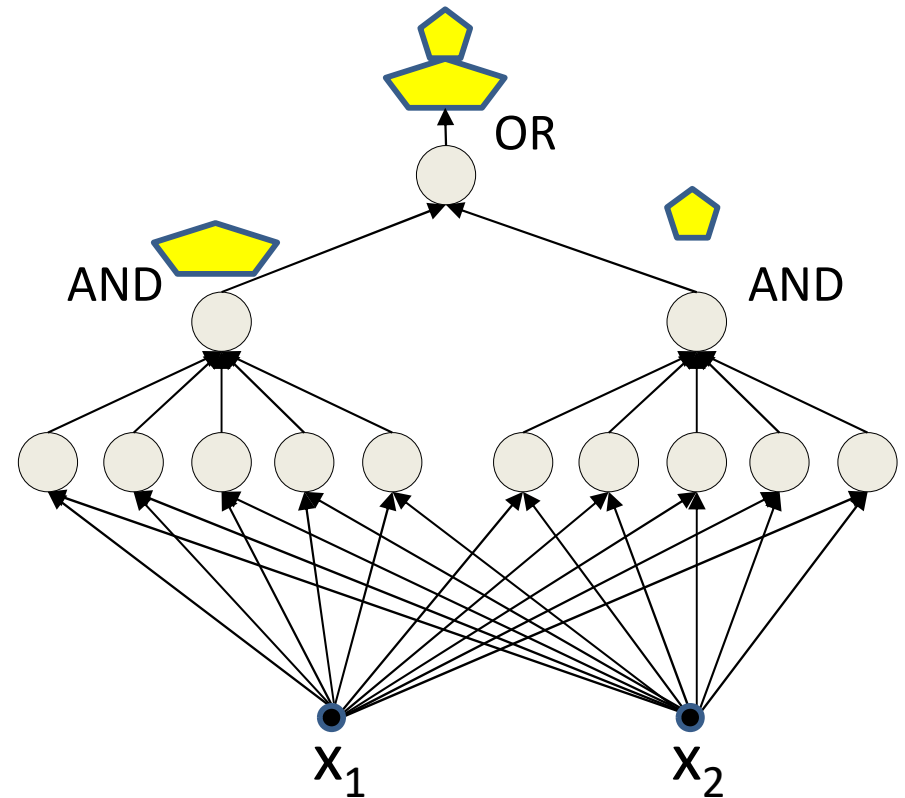
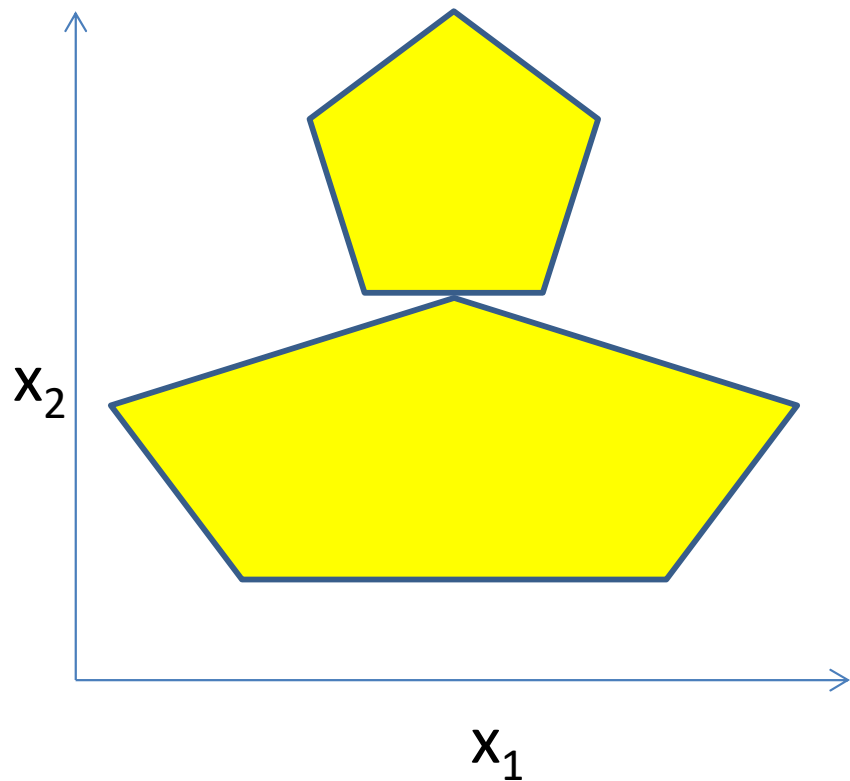

- Network to fire if the input is in the yellow area
 - “OR” two polygons
 - A third layer is required

Complex decision boundaries

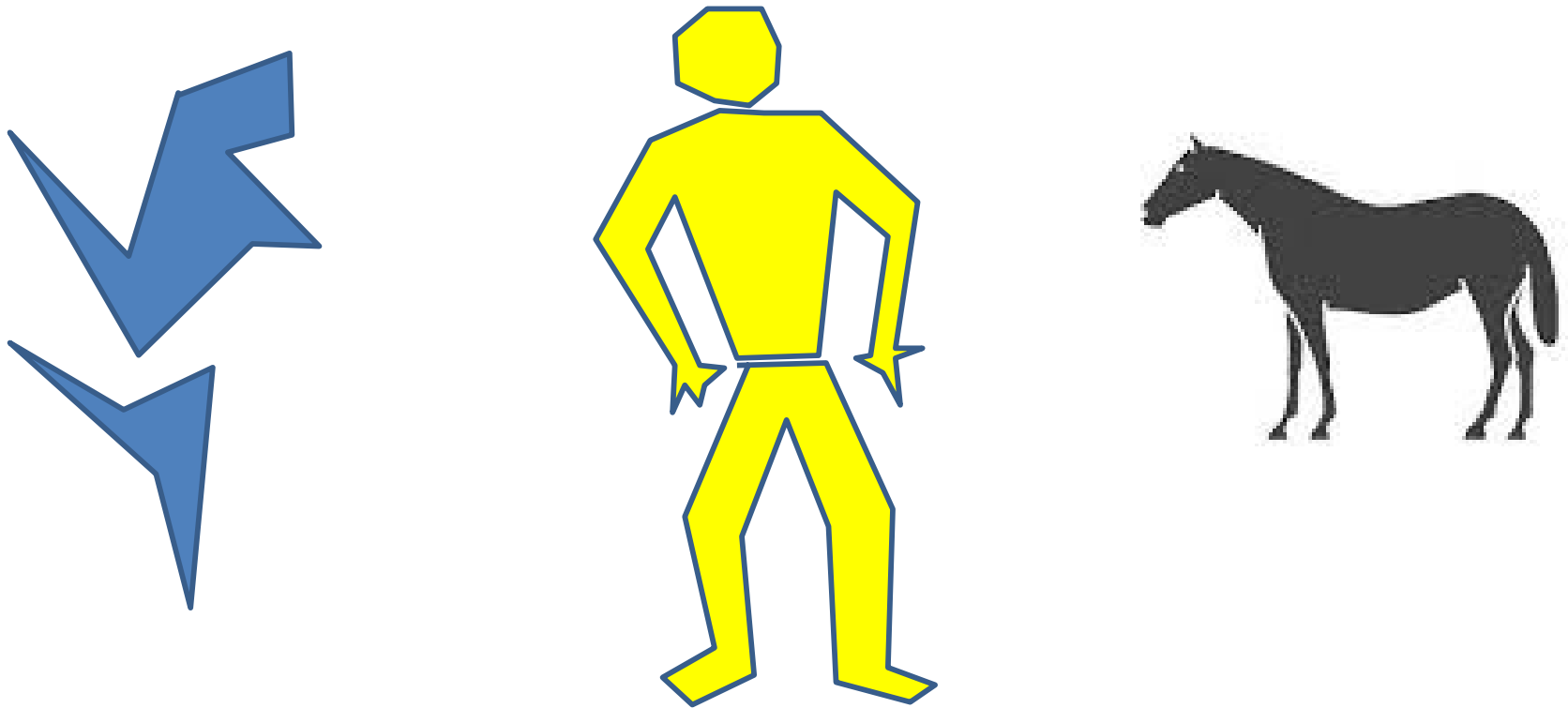

- Can compose very complex decision boundaries
 - How complex exactly? More on this in the next class

Complex decision boundaries

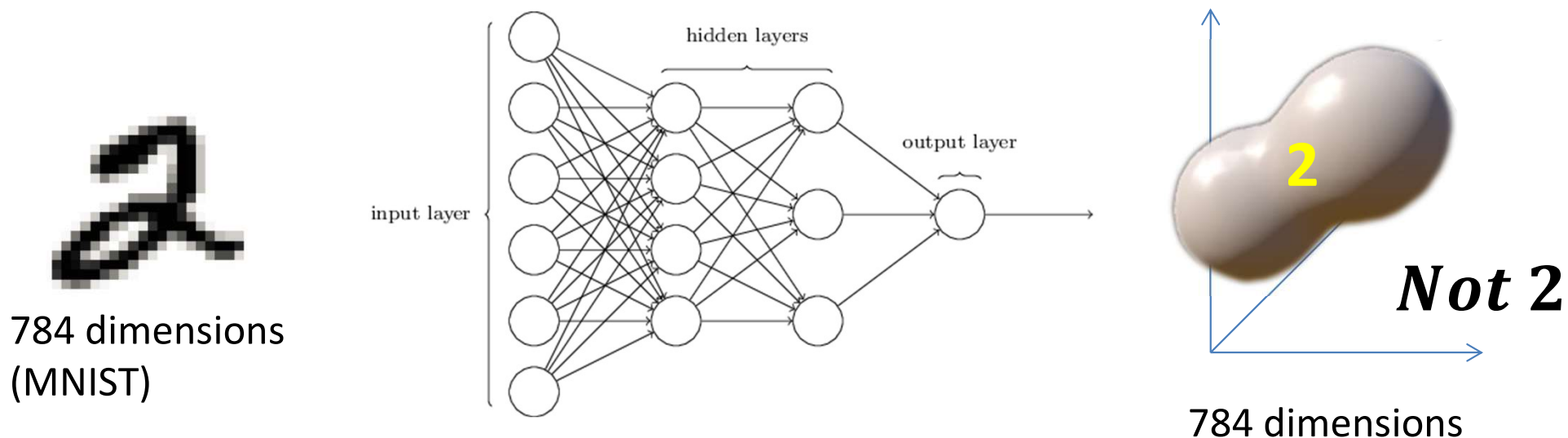

- Classification problems: finding decision boundaries in high-dimensional space
 - Can be performed by an MLP
- MLPs can *classify* real-valued inputs
- They are universal classifiers
 - For any decision boundary, we can construct an MLP that captures it with arbitrary precision

Story so far

- **MLPs are connectionist computational models**
 - Individual perceptrons are computational equivalent of neurons
 - The MLP is a layered composition of many perceptrons
- **MLPs can model any Boolean function**
 - Individual perceptrons can act as Boolean gates
 - Networks of perceptrons are Boolean functions
 - MLPs are universal Boolean functions
- **MLPs are model any decision boundary**
 - Individual perceptrons capture linear boundaries
 - Complex boundaries can be composed from the linear boundaries
 - MLPs can represent arbitrary decision boundaries
 - They can be used to *classify* data
 - MLPs are universal classifiers

Poll 3

How many threshold activation perceptrons will we need in an MLP to model a hexagonal decision region (a decision region bounded by a six-sided polygon) over a two-dimensional input space? (Single Choice)

- 6
- 7
- 12
- 13

Poll 3

How many threshold activation perceptrons will we need in an MLP to model a hexagonal decision region (a decision region bounded by a six-sided polygon) over a two-dimensional input space? (Single Choice)

- 6
- **7**
- 12
- 13

But what about continuous valued *outputs?*

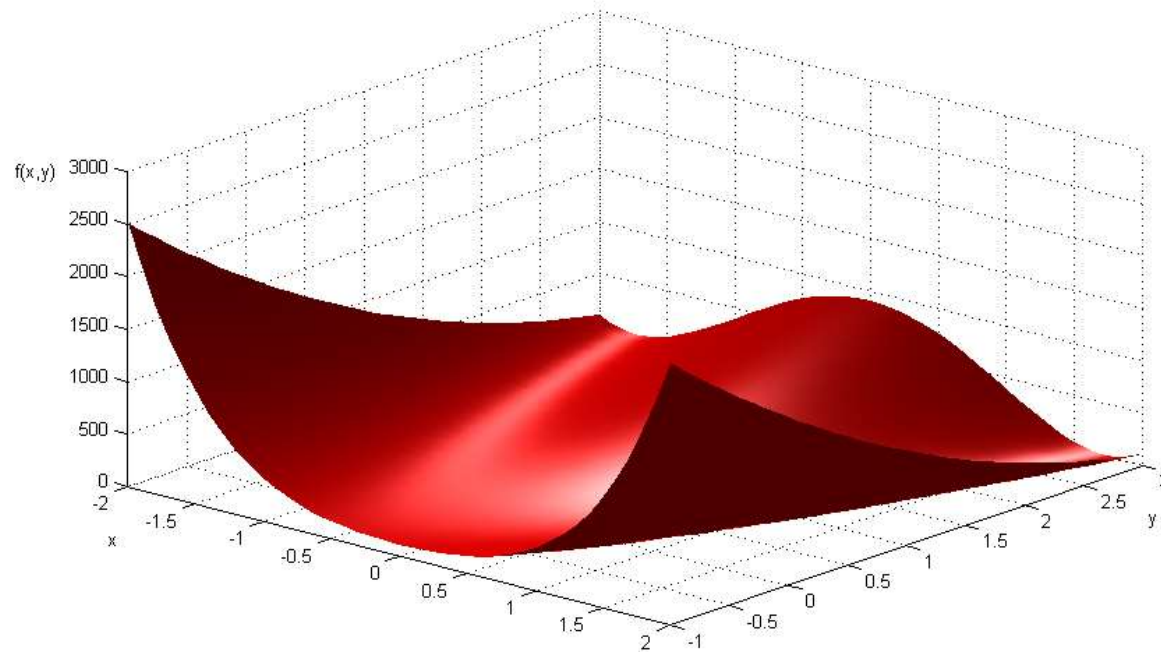

- Inputs may be real-valued
- Can outputs be continuous-valued too?

MLP as a continuous-valued regression

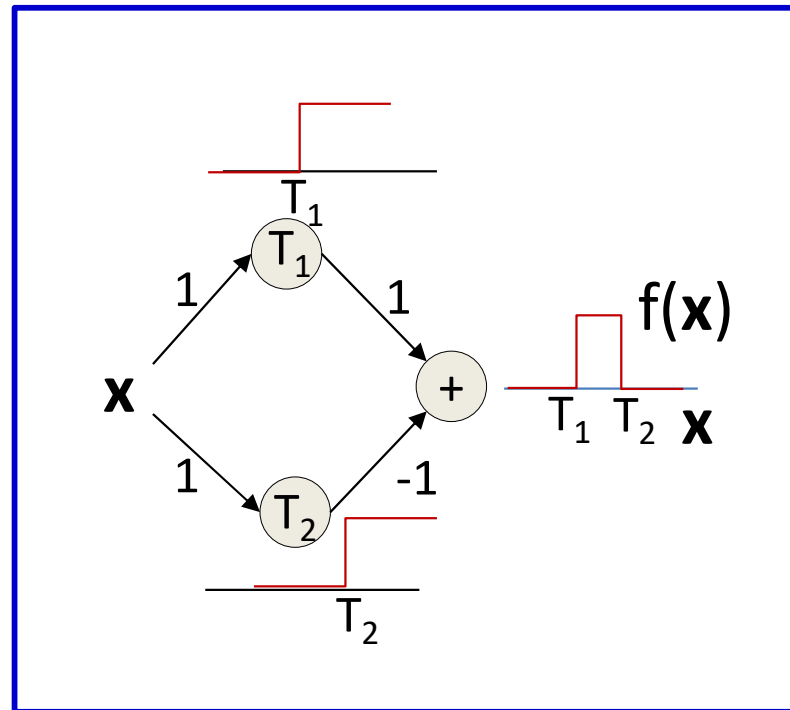

- A simple 3-unit MLP with a “summing” output unit can generate a “square pulse” over an input
 - Output is 1 only if the input lies between T_1 and T_2
 - T_1 and T_2 can be arbitrarily specified

MLP as a continuous-valued regression

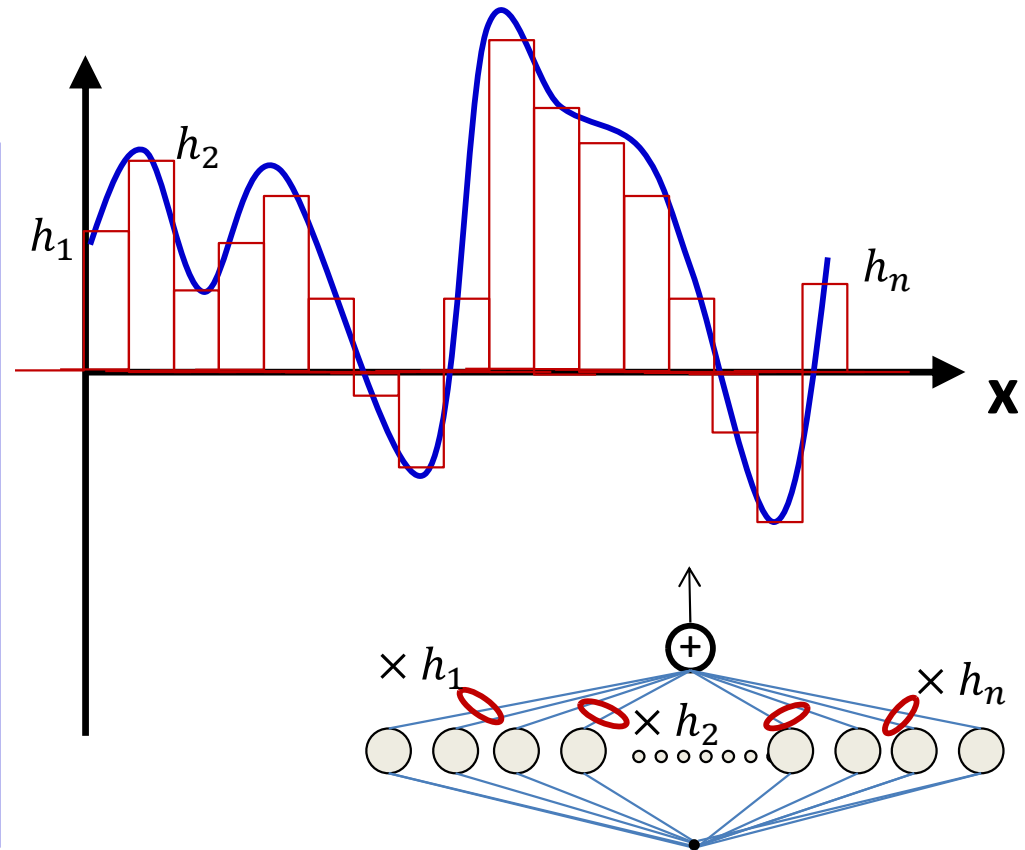
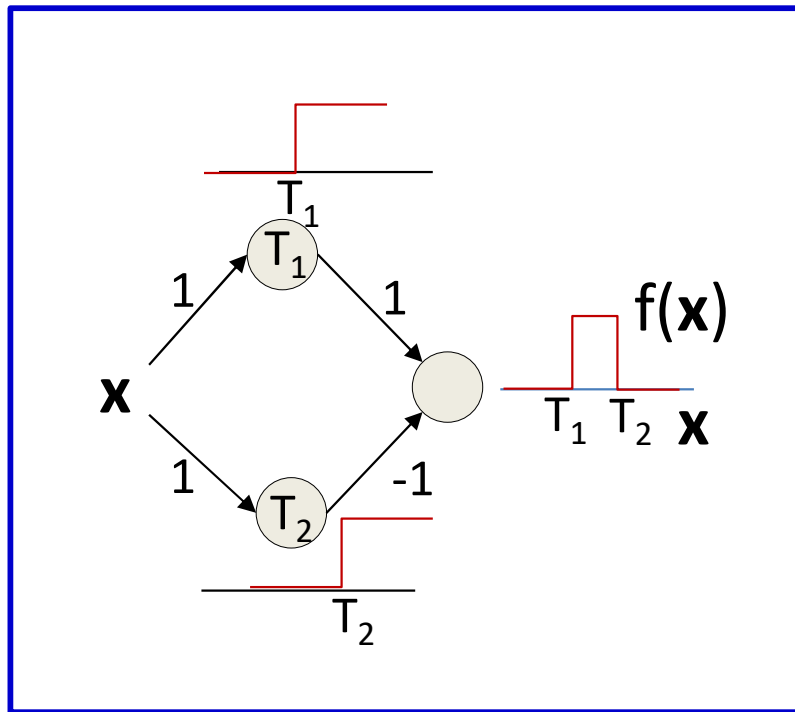

- A simple 3-unit MLP can generate a “square pulse” over an input
- **An MLP with many units can model an arbitrary function over an input**
 - To arbitrary precision
 - Simply make the individual pulses narrower
- This generalizes to functions of any number of inputs (next class)

Poll 4

How many neurons will be required by a network of sinusoidal ($y = \sin(z)$) activation neurons to precisely model the scalar function $y = \cos(2x)$ (for scalar input x)? (Single Choice)

- 3
- $\text{floor}(\pi/2)$ or $\text{ceil}(\pi/2)$
- infinite
- none of the above

Poll 4

How many neurons will be required by a network of sinusoidal ($y = \sin(z)$) activation neurons to precisely model the scalar function $y = \cos(2x)$ (for scalar input x)? (Single Choice)

- 3
- $\text{floor}(\pi/2)$ or $\text{ceil}(\pi/2)$
- infinite
- **none of the above**

Explanation: you only need one

Story so far

- **Multi-layer perceptrons are connectionist computational models**
- **MLPs are *classification engines***
 - They can identify classes in the data
 - Individual perceptrons detect individual boundaries
 - The network will fire if the combination of the outputs of the individual perceptrons falls within the decision boundary for a desired class of input
- **MLP can also model continuous valued functions**

Other things MLPs can do

- Model memory
 - Loopy networks can “remember” patterns
 - Proposed by Lawrence Kubie in 1930, as a model for memory in the CNS
- Represent probability distributions
 - Over integer, real and complex-valued domains
 - MLPs can model both *a posteriori* and *a priori* distributions of data
 - A posteriori conditioned on other variables
 - MLPs can *generate* data from complicated, or even unknown distributions
- They can rub their stomachs and pat their heads at the same time..

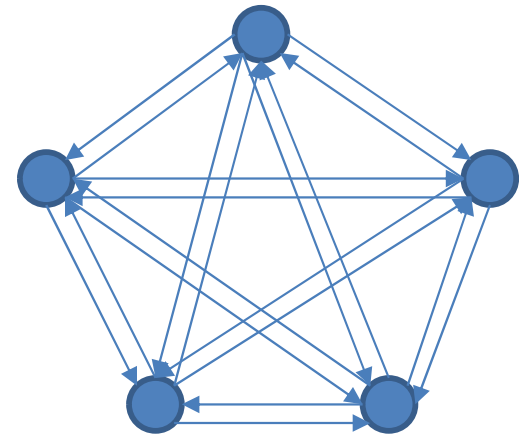

NNets in AI

- The network is a function
 - Given an input, it computes the function layer wise to predict an output
 - More generally, given one or more inputs, predicts one or more outputs

These tasks are *functions*

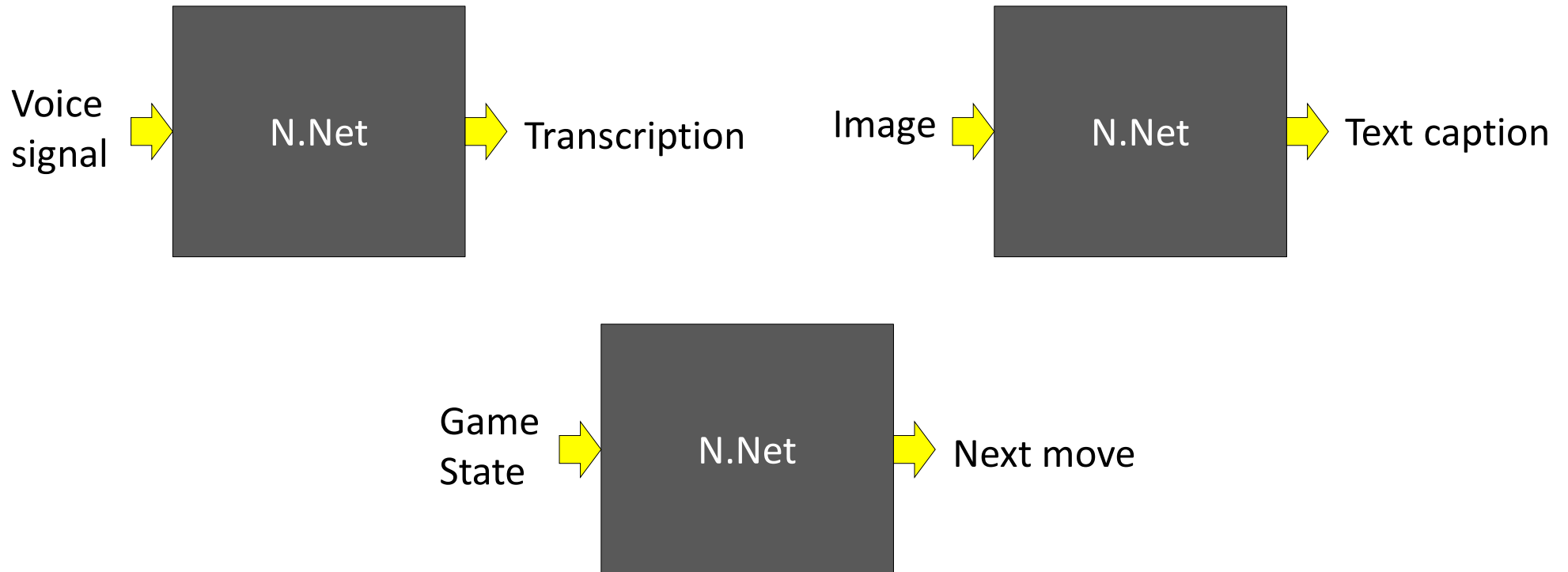

- Each of these boxes is actually a function
 - E.g $f: \text{Image} \rightarrow \text{Caption}$

These tasks are *functions*

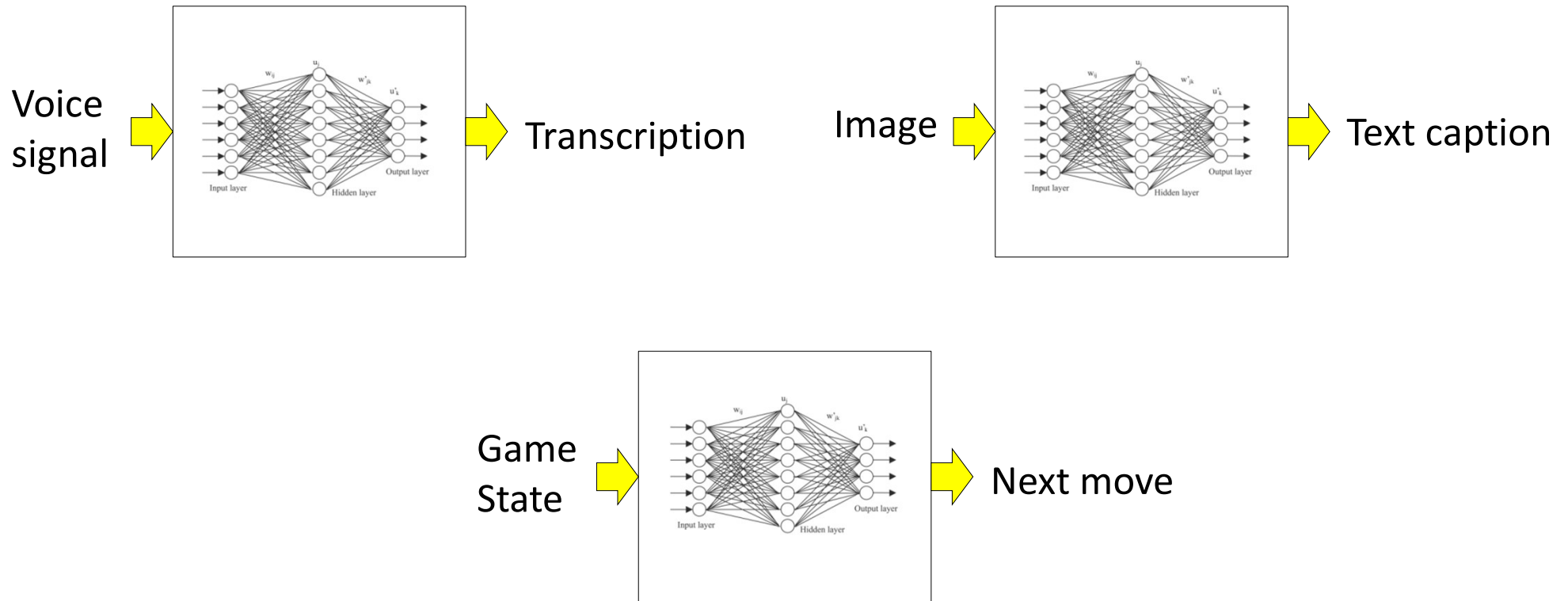



- Each box is actually a function
 - E.g $f: \text{Image} \rightarrow \text{Caption}$
 - It can be approximated by a neural network

Story so far

- **Multi-layer perceptrons are connectionist computational models**
- **MLPs are *classification engines***
- **MLP can also model continuous valued functions**
- **Interesting AI tasks are functions that can be modelled by the network**

Today's lessons

- A brief history of neural networks 
 - Connectionism
 - Its relation to cognition and the brain
 - Its contrast to conventional computer architecture
 - Early models, and their limitations
- Introducing modern neural networks 
- And what they can compute 

Next Up

- More on neural networks as universal approximators
 - And the issue of depth in networks